



GIUSTACCHINI
ARREDO

CATALOGO
SEMPRE
PRONTI
10 GIORNI

GIUSTACCHINI
ARREDO



Azienda con sistema di gestione qualità certificato



UNI EN ISO 9001:2015 fa riferimento ai sistemi di **gestione della qualità**, cioè alle strutture organizzative che l'impresa deve adottare per garantire che il prodotto finito sia in linea con i requisiti specificati dalle esigenze del cliente.

UNI EN ISO 14001:2015 fa riferimento al sistema di **gestione ambientale**, in particolare certifica che l'azienda rispetta le norme vigenti in materia ambientale, adotta una seria politica ambientale e si impegna a ridurre nel tempo i propri fattori d'impatto ambientale attraverso un efficace sistema di gestione aziendale.

UNI EN ISO 45001:2018 fa riferimento al sistema di **gestione della sicurezza e salute sul lavoro** e certifica il corretto controllo in materia di salute e sicurezza negli ambienti di lavoro e il rispetto delle leggi cogenti da parte dell'azienda.

Condizioni generali di vendita

1) Disposizioni Generali

1.1 I termini e le condizioni qui di seguito indicati (le "Condizioni Generali di Vendita"), formano parte integrante di qualsiasi Ordine e/o Contratto stipulato tra il Venditore e l'Acquirente per la fornitura dei Prodotti del Venditore e prevalgono su eventuali condizioni generali di acquisto predisposte dall'Acquirente, anche nell'ipotesi in cui si faccia loro riferimento o siano contenute negli ordini o in qualsiasi altra documentazione di provenienza dell'Acquirente, senza il preventivo consenso scritto di Sedioliti e pertanto neppure per effetto di tacito consenso. Per ogni Ordine e/o Contratto trova applicazione il Codice del Consumo (D.Lgs 206/2005) e s.m.i.

Le Condizioni Generali di Vendita, salvo eventuali deroghe specificamente concordate per iscritto, si applicheranno a tutte le forniture future di beni o servizi da parte del Venditore fino ad una nuova edizione delle stesse.

1.2 Sedioliti si riserva, pertanto, in forma scritta, la revisione periodica delle presenti Condizioni Generali di Vendita, la cui versione aggiornata, sarà messa a disposizione del Cliente in allegato alle offerte ovvero ad altra corrispondenza inviata per iscritto all'Acquirente relativa agli ordini.

1.3 Se l'Acquirente non restituirà la copia della conferma d'ordine e/o dell'ordine sottoscritta o non invierà propria conferma di acquisto, l'ordine si intenderà in ogni caso tacitamente ed integralmente confermato entro 2 giorni. Gli ordini effettuati dall'Acquirente non s'intendono accettati finché non siano stati confermati per iscritto dal Venditore. Gli ordini e/o le modifiche di ordini effettuati verbalmente o telefonicamente devono essere confermati per iscritto da parte dell'Acquirente. In caso contrario il Venditore non si assume alcuna responsabilità con riguardo ad eventuali errori o possibili fraintendimenti. Nel caso in cui il Venditore non provveda alla conferma per iscritto di un ordine negoziato verbalmente, l'emissione della fattura da parte del Venditore oppure l'esecuzione dell'ordine da parte del Venditore sarà considerata quale conferma.

1.4 Considerata la costante miglioria ed evoluzione tecnica, ITALIAN SEDIOLITI SRL si riserva la facoltà di apportare modifiche e migliorie alla produzione, senza alcun preavviso. Foto e dati tecnici del catalogo e del listino sono indicativi.

2) Prezzi

2.1 I prezzi dei Prodotti saranno quelli indicati nel listino prezzi di ITALIAN SEDIOLITI SRL in vigore al momento dell'ordine da parte dell'Acquirente o, qualora il Prodotto non sia inserito nel listino prezzi o il listino prezzi non sia disponibile, quelli indicati nell'ordine e confermati per iscritto da ITALIAN SEDIOLITI SRL al momento dell'accettazione dell'ordine.

Il listino in vigore può essere soggetto a variazioni senza preavviso, sostituendo integralmente il precedente.

2.2 In caso di pagamenti concordati in misura dilazionata, qualora non venisse pagata puntualmente anche una sola rata di prezzo, il Venditore potrà esigere immediatamente l'intero prezzo con decadenza dal beneficio del termine dell'Acquirente anche se non ricorrono le condizioni di cui all'art. 1186 del Codice Civile. In alternativa il Venditore potrà sospendere e considerare risolto il contratto per inadempimento e trattenere tutte le somme nel frattempo versate dall'Acquirente in conto dell'eventuale maggiore avere a titolo di risarcimento danno.

Anche in caso di notifica di contestazioni per vizi e difetti, l'Acquirente non potrà iniziare o proseguire azioni se prima non avrà integralmente pagato il prezzo nei termini del contratto. I pagamenti, in nessun caso, potranno essere sospesi o ritardati: qualora fossero insorte contestazioni, le relative azioni non potranno essere iniziate o proseguite se prima non si sarà provveduto al pagamento del prezzo secondo i termini e i modi stabiliti.

2.3 La sospensione della consegna dei Prodotti o la risoluzione del contratto di Vendita non darà il diritto all'Acquirente di pretendere alcun risarcimento dei danni.

2.4 I prezzi in EURO si intendono IVA esclusa.

2.5

ITALIA: resa della merce franco VOSTRA SEDE senza oneri per ordini di importo netto superiori ad eur 500: per ordini inferiori verrà addebitato un contributo di eur 25

ISOLE: resa della merce franco VOSTRA SEDE senza oneri per ordini di importo netto superiori ad eur 700: per ordini inferiori verrà addebitato un contributo di eur 35

Per consegne con DESTINAZIONE DIVERSA DA VOSTRA SEDE preghiamo contattare preventivamente i ns. ufficio per gli eventuali costi aggiuntivi.

3) Consegna

3.1 Tutti i termini temporali - di consegna, resa, posa in opera, ecc. - anche se definiti tassativi dall'Acquirente, si intendono comunque indicativi e assunti dal Venditore con ogni tolleranza d'uso. Se non diversamente concordato per iscritto, qualsiasi termine di consegna indicato non è vincolante per il Venditore. Salvo diverso accordo tra le parti, il termine di consegna indicativo è quello precisato nella conferma d'ordine.

I ritardi non danno in nessun caso alcun diritto a penalità e/o rimborso per danno diretto o indiretto alcuno, a nessun titolo né tanto meno all'annullamento o risoluzione del contratto di Vendita.

3.2 In ogni caso ITALIAN SEDIOLITI SRL non sarà considerata responsabile dei ritardi o della mancata consegna ascrivibili a circostanze che siano fuori dal suo controllo, quali a titolo meramente esemplificativo e senza pretesa di esaustività: a) imprecisioni o ritardi dell'Acquirente nella trasmissione a ITALIAN SEDIOLITI SRL di informazioni o dati necessari alla spedizione dei Prodotti; b) difficoltà nell'ottenere rifornimenti delle materie prime; c) problemi legati alla produzione o alla pianificazione degli ordini; d) scioperi parziali o totali, mancanza di energia elettrica, calamità naturali, misure imposte dalle autorità pubbliche, difficoltà nel trasporto, disordini, attacchi terroristici e tutte le altre cause di forza maggiore.

3.3 Il verificarsi di alcuni degli eventi sopra elencati non darà diritto al Cliente di richiedere il risarcimento degli eventuali danni o indennizzi di alcun genere.

4) Imballi

4.1 ITALIAN SEDIOLITI SRL effettua la consegna delle merci ordinate secondo le quantità standard previste per confezione come specificato a listino/catalogo. In caso di mancata corrispondenza la quantità verrà arrotondata, senza preavviso, alla quantità stabilita per confezione o multipla di essa.

4.2 Gli imballi utilizzati dovranno essere smaltiti secondo le modalità previste dalle leggi nazionali in vigore, ITALIAN SEDIOLITI SRL declina ogni responsabilità per danni a persone o cose per uso difforme da quello cui essi sono stati concepiti.

5) Resi

Il Venditore non è obbligato ad accettare resi dei Prodotti, salvo che sia stato espressamente pattuito per iscritto. Qualsiasi costo a tal fine sostenuto è a carico dell'Acquirente.

6) Reclami

Qualsiasi difformità dei Prodotti consegnati all'Acquirente rispetto al tipo ed alla quantità indicata nell'ordine dovrà essere denunciata per iscritto all'indirizzo info@italiansedioliti.it entro 7 (sette) giorni dalla data di consegna. Qualora la denuncia non venga comunicata entro il predetto termine, i Prodotti consegnati verranno considerati come conformi a quelli ordinati dall'Acquirente.

7) Termini generali di garanzia

7.1 La garanzia fornita da ITALIAN SEDIOLITI SRL ha validità variabile dalla data di acquisto, a seconda del modello interessato (vedesi ns. listino prezzi) eccetto per le parti soggette a logoramento (ruote, gas, meccanismi, tessuti) per le quali la garanzia è 12 mesi.

Un eventuale difetto di fabbricazione o dei materiali dovrà essere comunque convalidato da ITALIAN SEDIOLITI SRL previo ricevimento di idonea richiesta scritta corredata di documentazione fotografica, numero di bolla o tramite accertamento diretto da parte di incaricati ITALIAN SEDIOLITI SRL.

La garanzia si basa su un normale impiego giornaliero di 8 ore per 220 gg. lavorativi annuali.

Per garanzia si intende la sostituzione del o dei componenti riconosciuti non conformi e invalidanti l'utilizzo per difetti di origine o di fabbricazione con le seguenti modalità:

PERIODO DI GARANZIA FINO ALLA SPECIFICA SCADENZA	PRODOTTI BOOK (Made in Italy) PEZZI SOSTITUTIVI A CARICO:	PRODOTTI BOOK (Made in Italy) TRASPORTO A CARICO:	PRODOTTI IMPORT PEZZI SOSTITUTIVI A CARICO:	PRODOTTI IMPORT TRASPORTO A CARICO:
Da 0 a 12 mesi	ITALIAN SEDIOLITI SRL	ITALIAN SEDIOLITI SRL	ITALIAN SEDIOLITI SRL	ITALIAN SEDIOLITI SRL
Da 13 a 24 mesi (secondo garanzia specifica)	ITALIAN SEDIOLITI SRL / CLIENTE	ITALIAN SEDIOLITI SRL / CLIENTE	ITALIAN SEDIOLITI SRL / CLIENTE	ITALIAN SEDIOLITI SRL / CLIENTE
Da 25 a 60 mesi (secondo garanzia specifica)	ITALIAN SEDIOLITI SRL / CLIENTE	CLIENTE	ITALIAN SEDIOLITI SRL / CLIENTE	CLIENTE

7.2 Con l'obbligazione di garanzia il Venditore non assume alcuna ulteriore obbligazione di risarcimento danno diretto e/o indiretto e/o consequenziale derivante all'Acquirente o a terzi da difetti del Prodotto (in via esemplificativa anche a titolo di perdite di produzione, danni a cose o persone, mancato guadagno ecc.).

7.3 I termini sopra descritti possono essere integrati da condizioni aggiuntive applicate su linee di prodotto specifiche. A titolo esemplificativo ma non esaustivo, non sono coperti da Garanzia i Prodotti con difetti causati dal trasporto, da alterazioni e/o variazioni del Prodotto causate da eventi naturali o errato stoccaggio, installazioni errate, manomissione e/o riparazioni effettuate da persone non autorizzate, mancanza di manutenzione adeguata o inosservanza delle istruzioni d'uso, utilizzo di Prodotti e/o attrezzature non idonee, normale usura, deterioramento dovuto all'uso e da ogni altra causa non riconducibile ad un difetto originario del Prodotto.

8) Montaggio e assemblaggio

8.1 Il materiale ITALIAN SEDIOLITI SRL deve essere montato e assemblato rispettando le istruzioni fornite dal fornitore.

ITALIAN SEDIOLITI SRL declina ogni responsabilità in caso di errata messa in opera del materiale.

9) Insolvenza

9.1 L'insolvenza eventuale, anche se parziale, dell'Acquirente, da irrevocabile facoltà a ITALIAN SEDIOLITI SRL, ai sensi e per gli effetti di cui agli art. 1453 e 1456 del Codice Civile, di sospendere immediatamente ogni fornitura e in ogni caso, ITALIAN SEDIOLITI SRL avrà diritto a sospendere l'adempimento delle obbligazioni derivanti dalla vendita dei Prodotti, in base all'art. 1461 del Codice Civile, nel caso in cui le condizioni patrimoniali dell'Acquirente o dubbi sulle stesse diversissero tali da porre in serio pericolo il conseguimento della controprestazione salvo che sia prestata idonea garanzia.

9.2 In caso di ritardato pagamento verranno addebitati gli interessi di mora al tasso BCE maggiorato di otto punti, oltre alle spese di recupero ai sensi della direttiva 2011/7/UE.

10) Riservato dominio

10.1 Le merci sono vendute con il patto di riservato dominio ai sensi dell'art. 1523 e segg. del Codice Civile; di conseguenza sino al totale pagamento dell'intero prezzo, esse rimarranno di proprietà di ITALIAN SEDIOLITI SRL.

10.2 Nell'ipotesi di azioni esercitate da terzi nei confronti dei Prodotti del Venditore forniti ed assoggettati alla riserva di proprietà, l'Acquirente dovrà comunicare ai terzi il fatto che gli stessi sono di proprietà del Venditore e dovrà informare immediatamente il Venditore di tale azione. L'Acquirente sosterrà tutti i costi relativi a tale intervento.

11) Controversie

11.1 Tutti i contratti di vendita fra le parti nonché le presenti Condizioni Generali di Vendita saranno disciplinati dalla legge italiana.

11.2 Qualsiasi controversia insorta tra le parti a seguito dell'interpretazione, validità o esecuzione delle presenti Condizioni Generali di Vendita e dei relativi contratti stipulati sarà devoluta alla competenza esclusiva del Tribunale di Forlì.

11.3 Resta inteso tra le parti che soltanto il Venditore, a propria discrezione, avrà la facoltà di rinunciare alla competenza del foro esclusivo di cui al precedente paragrafo per agire in giudizio nei confronti dell'Acquirente, al suo domicilio e presso il Tribunale ivi competente.

12) Disposizioni finali

12.1 L'invalidità in tutto o in parte di singole disposizioni delle presenti Condizioni Generali di Vendita non inficia la validità delle restanti previsioni.

N.B. I colori della cartella tessuti fotografica possono avere differenze importanti con la cartella tessuti reali. Avvertiamo di volere sempre accertarsi della tonalità colore desiderata.



ITALIANS LESAC



TENDENCE 900



TENDENCE 400



SEDUTA GIUSTA



FERRET



MODEL ONE



SIMPLEMESH



OVI



MODEL TWO



OP



CHF



SAP

Disponibili in 5 giorni fino ad un massimo di 10-12 poltrone,
per quantità superiori 7-10 giorni.



WAVE



ALUMESH



BASIC



617



EMIRO



FIXRO



WH FINTA PELLE



WH RETE



VT NYLON



BRILLMESH
(NERA)



BRILLMESH
(BIANCA)



KOS

Disponibili in 5 giorni salvo rottura di stock

IMPORT

ITALIANS LESAC	8-9
TENDENCE 900	10-11
TENDENCE 400	12-13
SEDUTA GIUSTA.....	14-15
FERRET	16-17
MODEL ONE.....	18-19
SIMPLEMESH.....	20-21
OVI.....	22-23
MODEL TWO.....	24-25
OP	26-27
CHF.....	28-29
SAP	30-31

SEMPRE PRONTI

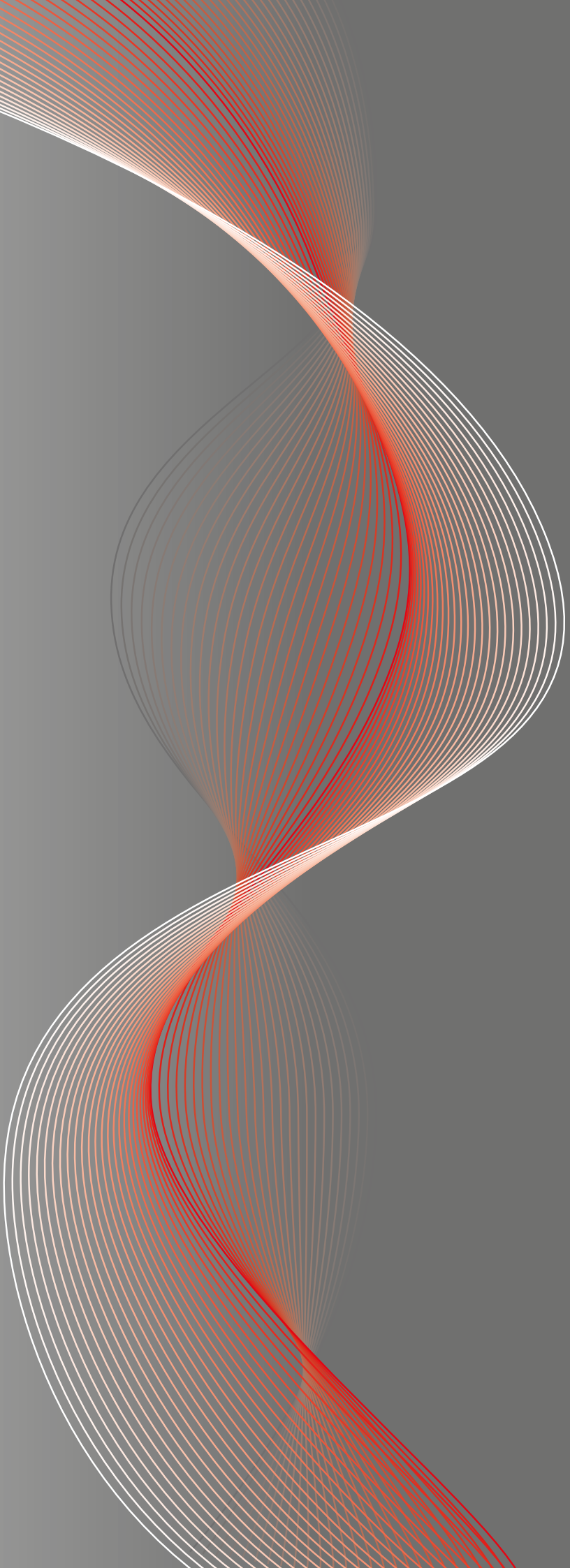

ITALIANS LESAC



ITALIANS LESAC



IT LS 110 SY5 T AM26 SP	DESCRIZIONE	  	RIVESTIMENTO																																										
	<p>POLTRONA DIREZIONALE ERGONOMICA REGOLABILE</p> <p>Schienale: ergonomico brevettato in polipropilene rinforzato, regolabile in altezza con meccanismo Up&Down.</p> <p>Sedile: esterno in polipropilene, interno in multistrato di faggio 12mm rivestito in resina espansa ignifuga ad alta densità (40 kg/m³), spessore 55mm.</p> <p>Braccioli: in alluminio e materiale plastico, regolabili in altezza, scorrimento, rotazione e larghezza. Pad in morbido PU.</p> <p>Meccanismo: syncro 5 blocchi con regolazione in base al peso dell'utilizzatore e dispositivo anti ritorno. Traslatore per regolazione profondità della seduta.</p> <p>Elevazione seduta: gaslift classe 4.</p> <p>Base: in alluminio spazzolato diametro 700mm.</p> <p>Ruote: autofrenanti di tipo W per tutti i pavimenti.</p>	<table border="1"> <tr> <td data-bbox="799 241 911 300">EN 1335 A (su richiesta)</td> <td data-bbox="911 241 1011 300">CAM</td> <td data-bbox="1011 241 1112 300">1 M</td> <td colspan="4"></td> </tr> <tr> <td colspan="7" data-bbox="799 300 1225 488">  </td> </tr> <tr> <td data-bbox="799 488 863 546">A1</td> <td data-bbox="863 488 911 546">B</td> <td data-bbox="911 488 959 546">C</td> <td data-bbox="959 488 1007 546">D</td> <td data-bbox="1007 488 1054 546">E</td> <td data-bbox="1054 488 1102 546">F</td> <td data-bbox="1102 488 1225 546">G</td> </tr> <tr> <td data-bbox="799 546 863 568">120/132</td> <td data-bbox="863 546 911 568">88</td> <td data-bbox="911 546 959 568">47</td> <td data-bbox="959 546 1007 568">47</td> <td data-bbox="1007 546 1054 568">47</td> <td data-bbox="1054 546 1102 568">45/57</td> <td data-bbox="1102 546 1225 568">70</td> </tr> <tr> <td colspan="7" data-bbox="799 568 1225 591">  </td> </tr> <tr> <td data-bbox="799 591 863 658">x 1</td> <td data-bbox="863 591 911 658">0,22</td> <td data-bbox="911 591 959 658">21</td> <td data-bbox="959 591 1007 658">110</td> <td data-bbox="1007 591 1054 658">5</td> <td colspan="2" data-bbox="1054 591 1225 658">GARANZIA</td> </tr> </table>	EN 1335 A (su richiesta)	CAM	1 M												A1	B	C	D	E	F	G	120/132	88	47	47	47	45/57	70								x 1	0,22	21	110	5	GARANZIA		<p>Schienale e sedile in finta pelle ignifuga AUREA MOOD (NERO) 87795641</p>
EN 1335 A (su richiesta)	CAM	1 M																																											
																																													
A1	B	C	D	E	F	G																																							
120/132	88	47	47	47	45/57	70																																							
																																													
x 1	0,22	21	110	5	GARANZIA																																								
BRACCIOLI INCLUSI																																													



IT LS 50 SL AM26 SP	DESCRIZIONE	  	RIVESTIMENTO																																										
	<p>POLTRONA ERGONOMICA VISITATORE - RIUNIONE</p> <p>Schienale: ergonomico brevettato in polipropilene rinforzato.</p> <p>Sedile: esterno in polipropilene, interno in multistrato di faggio 12mm rivestito in resina espansa ignifuga ad alta densità (40 kg/m³), spessore 55mm.</p> <p>Slitta: tubo d'acciaio cromato diametro 25mm con braccioli integrati e appoggio in polipropilene nero, piedini nylon anti scivolo.</p>	<table border="1"> <tr> <td data-bbox="799 882 911 940">EN 16139 (in iter)</td> <td data-bbox="911 882 1011 940">CAM</td> <td data-bbox="1011 882 1112 940">1 M</td> <td colspan="4"></td> </tr> <tr> <td colspan="7" data-bbox="799 940 1225 1128">  </td> </tr> <tr> <td data-bbox="799 1128 863 1187">A1</td> <td data-bbox="863 1128 911 1187">B</td> <td data-bbox="911 1128 959 1187">C</td> <td data-bbox="959 1128 1007 1187">D</td> <td data-bbox="1007 1128 1054 1187">E</td> <td data-bbox="1054 1128 1102 1187">F</td> <td data-bbox="1102 1128 1225 1187">G</td> </tr> <tr> <td data-bbox="799 1187 863 1209">98</td> <td data-bbox="863 1187 911 1209">66</td> <td data-bbox="911 1187 959 1209">47</td> <td data-bbox="959 1187 1007 1209">47</td> <td data-bbox="1007 1187 1054 1209">47</td> <td data-bbox="1054 1187 1102 1209">48</td> <td data-bbox="1102 1187 1225 1209">67</td> </tr> <tr> <td colspan="7" data-bbox="799 1209 1225 1232">  </td> </tr> <tr> <td data-bbox="799 1232 863 1299">x 1</td> <td data-bbox="863 1232 911 1299">0,32</td> <td data-bbox="911 1232 959 1299">18</td> <td data-bbox="959 1232 1007 1299">110</td> <td data-bbox="1007 1232 1054 1299">5</td> <td colspan="2" data-bbox="1054 1232 1225 1299">GARANZIA</td> </tr> </table>	EN 16139 (in iter)	CAM	1 M												A1	B	C	D	E	F	G	98	66	47	47	47	48	67								x 1	0,32	18	110	5	GARANZIA		<p>Schienale e sedile in finta pelle ignifuga AUREA MOOD (NERO) 96956974</p>
EN 16139 (in iter)	CAM	1 M																																											
																																													
A1	B	C	D	E	F	G																																							
98	66	47	47	47	48	67																																							
																																													
x 1	0,32	18	110	5	GARANZIA																																								
BRACCIOLI INCLUSI NEL TELAIO																																													

TENDENCE 900 RETE

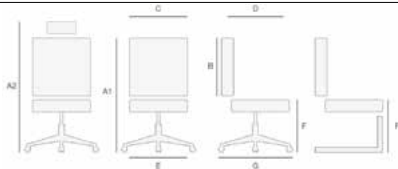

TENDENCE 900 RETE

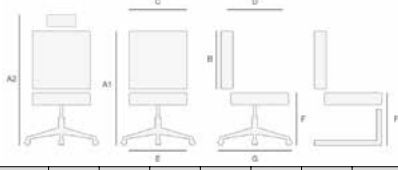
T900 RT SY4 T LIN SP	DESCRIZIONE	CATAS	GPP CAM	1 M	RIVESTIMENTO																
	<p>SEDIA DA UFFICIO DIREZIONALE-OPERATIVA, ERGONOMICA REGOLABILE CON SCHIENALE IN RETE E SEDILE IMBOTTITO</p> <p>Schienale: ergonomico brevettato in polipropilene rinforzato, regolabile in altezza con meccanismo Up&Down.</p> <p>Poggiareni: regolabile in altezza.</p> <p>Sedile: esterno ed interno in polipropilene, rinforzato tramite tubolare in acciaio. Rivestito in resina espansa ignifuga ad alta densità (40 kg/m³), spessore 60mm.</p> <p>Braccioli: Regolabili in 3 posizioni in altezza, scorrimenti e larghezze. In materiale plastico caricato, pad in pu.</p> <p>Meccanismo: syncro 4 blocchi con regolazione in base al peso dell'utilizzatore e dispositivo anti ritorno. Traslatore per regolazione profondità della seduta.</p> <p>Elevazione seduta: gaslift classe 4.</p> <p>Base: in nylon rinforzato + anello in acciaio di sicurezza separato da interporre tra gaslift e base per il sempre più richiesto facile riciclo dei singoli elementi.</p> <p>Ruote: autofrenanti di tipo W per tutti i pavimenti.</p>	EN 1335 A (su richiesta)	CAM	1 M	<p>Schienale in RETE ignifuga (NERA), sedile in tessuto ignifugo BERLIN (GRIGIO) 95500951</p>																
	<p>BRACCIOLI INCLUSI</p>	 <table border="1"> <thead> <tr> <th>A1</th> <th>B</th> <th>C</th> <th>D</th> <th>E</th> <th>F</th> <th>G</th> </tr> </thead> <tbody> <tr> <td>102/114</td> <td>60</td> <td>46</td> <td>43/50</td> <td>50</td> <td>43/52</td> <td>68</td> </tr> </tbody> </table>  <table border="1"> <tbody> <tr> <td>x 1</td> <td>0,18</td> <td>18</td> <td>110</td> <td>5</td> </tr> </tbody> </table>	A1	B		C	D	E	F	G	102/114	60	46	43/50	50	43/52	68	x 1	0,18	18	110
A1	B	C	D	E	F	G															
102/114	60	46	43/50	50	43/52	68															
x 1	0,18	18	110	5																	











T900 RT SL LIN SP	DESCRIZIONE	CATAS	GPP CAM	1 M	RIVESTIMENTO																
	<p>SEDIA DA UFFICIO VISITATORE - RIUNIONE CON SCHIENALE IN RETE E SEDILE IMBOTTITO</p> <p>Schienale: ergonomico brevettato in polipropilene rinforzato.</p> <p>Poggiareni: regolabile in altezza.</p> <p>Sedile: esterno ed interno in polipropilene, rinforzato tramite tubolare in acciaio. Rivestito in resina espansa ignifuga ad alta densità (40 kg/m³), spessore 60mm.</p> <p>Slitta: tubo d'acciaio verniciato nero diametro 25mm, piedini nylon anti scivolo.</p>	EN 1335 A (in iter)	CAM	1 M	<p>Schienale in RETE ignifuga (NERA), sedile in tessuto ignifugo BERLIN (GRIGIO) 66419458</p>																
	<p>BRACCIOLI INCLUSI</p>	 <table border="1"> <thead> <tr> <th>A1</th> <th>B</th> <th>C</th> <th>D</th> <th>E</th> <th>F</th> <th>G</th> </tr> </thead> <tbody> <tr> <td>105</td> <td>60</td> <td>46</td> <td>44</td> <td>50</td> <td>48</td> <td>60</td> </tr> </tbody> </table>  <table border="1"> <tbody> <tr> <td>x 1</td> <td>0,3</td> <td>14,5</td> <td>110</td> <td>5</td> </tr> </tbody> </table>	A1	B		C	D	E	F	G	105	60	46	44	50	48	60	x 1	0,3	14,5	110
A1	B	C	D	E	F	G															
105	60	46	44	50	48	60															
x 1	0,3	14,5	110	5																	

TENDENCE 400 RETE



TENDENCE 400 RETE

T400 RT SY4 LIN SP	DESCRIZIONE	  					RIVESTIMENTO																							
	<p>SEDIA DA UFFICIO OPERATIVA CON SCHIENALE IN RETE E SEDILE IMBOTTITO</p> <p>Schienale: ergonomico brevettato in polipropilene rinforzato, regolabile in altezza con meccanismo Up&Down.</p> <p>Poggiareni: regolabile in altezza unitariamente allo schienale, possibilità di rimozione.</p> <p>Sedile: polipropilene caricato ricoperto di resina espansa ignifuga ad alta densità (40 kg/m³), spessore 40mm. Imbottitura estraibile per facile sostituzione.</p> <p>Braccioli: Regolabili in altezza, in materiale plastico caricato, pad in materiale plastico.</p> <p>Meccanismo: syncro 4 blocchi con regolazione in base al peso dell'utilizzatore e dispositivo anti ritorno.</p> <p>Elevazione seduta: gaslift classe 4.</p> <p>Base: in nylon rinforzato + anello in acciaio di sicurezza separato da interporre tra gaslift e base per il sempre più richiesto facile riciclo dei singoli materiali.</p> <p>Ruote: autofrenanti di tipo W per tutti i pavimenti.</p>	EN 1335 B (su richiesta)	CAM	1 M			Schienale in RETE ignifuga (NERA), sedile in tessuto ignifugo BERLIN (GRIGIO) 57901312																							
								Schienale in RETE ignifuga (NERA), sedile in tessuto ignifugo BERLIN (NERO) 89390335																						
		<table border="1"> <thead> <tr> <th>A1</th> <th>B</th> <th>C</th> <th>D</th> <th>E</th> <th>F</th> <th>G</th> </tr> </thead> <tbody> <tr> <td>103/115</td> <td>60</td> <td>46</td> <td>45</td> <td>47</td> <td>42/54</td> <td>68</td> </tr> </tbody> </table>					A1		B	C	D	E	F	G	103/115	60	46	45	47	42/54	68	<table border="1"> <thead> <tr> <th></th> <th></th> <th></th> <th></th> <th>GARANZIA</th> </tr> </thead> <tbody> <tr> <td>x 1</td> <td>0,18</td> <td>18</td> <td>110</td> <td>5</td> </tr> </tbody> </table>						GARANZIA	x 1	0,18
A1	B	C	D	E	F	G																								
103/115	60	46	45	47	42/54	68																								
				GARANZIA																										
x 1	0,18	18	110	5																										
BRACCIOLI INCLUSI																														

T400 RT SL LIN SP	DESCRIZIONE	  					RIVESTIMENTO																							
	<p>SEDIA DA UFFICIO VISITATORE - RIUNIONE CON SCHIENALE IN RETE E SEDILE IMBOTTITO</p> <p>Schienale: ergonomico brevettato in polipropilene rinforzato.</p> <p>Sedile: polipropilene caricato ricoperto di resina espansa ignifuga ad alta densità (40 kg/m³), spessore 40mm. Imbottitura estraibile per facile sostituzione.</p> <p>Slitta: tubo d'acciaio verniciato nero diametro 25mm, piedini nylon anti scivolo.</p>	EN 16139 (in iter)	CAM	1 M			Schienale in RETE ignifuga (NERA), sedile in tessuto ignifugo BERLIN (GRIGIO) 31744655																							
								Schienale in RETE ignifuga (NERA), sedile in tessuto ignifugo BERLIN (NERO) 04852616																						
		<table border="1"> <thead> <tr> <th>A1</th> <th>B</th> <th>C</th> <th>D</th> <th>E</th> <th>F</th> <th>G</th> </tr> </thead> <tbody> <tr> <td>105</td> <td>60</td> <td>46</td> <td>44</td> <td>47</td> <td>48</td> <td>60</td> </tr> </tbody> </table>					A1		B	C	D	E	F	G	105	60	46	44	47	48	60	<table border="1"> <thead> <tr> <th></th> <th></th> <th></th> <th></th> <th>GARANZIA</th> </tr> </thead> <tbody> <tr> <td>x 1</td> <td>0,3</td> <td>13,5</td> <td>110</td> <td>5</td> </tr> </tbody> </table>						GARANZIA	x 1	0,3
A1	B	C	D	E	F	G																								
105	60	46	44	47	48	60																								
				GARANZIA																										
x 1	0,3	13,5	110	5																										
BRACCIOLI INCLUSI																														

SEDUTA GIUSTA



SEDUTA GIUSTA

T 400 RT PU	DESCRIZIONE	RIVESTIMENTO																																			
	<p>SEDIA DA UFFICIO OPERATIVA CON SCHIENALE IN RETE E SEDILE IMBOTTITO</p> <p>Schienale: ergonomico brevettato in polipropilene rinforzato ricoperto con rete, regolabile in altezza con meccanismo Up&Down.</p> <p>Poggiareni: a scarico dorsale, regolabile in altezza con possibilità di rimozione.</p> <p>Sedile: polipropilene caricato ricoperto di resina espansa ignifuga ad alta densità (40 kg/m³), spessore 40mm. Imbottitura estraibile per facile sostituzione.</p> <p>Braccioli: Regolabili in altezza, in materiale plastico caricato, pad in materiale plastico.</p> <p>Meccanismo: syncro 5 blocchi con regolazione in base al peso dell'utilizzatore e dispositivo anti ritorno e antishock.</p> <p>Elevazione seduta: gaslift classe 4.</p> <p>Base: in acciaio cromato.</p> <p>Ruote: autofrenanti di tipo W per tutti i pavimenti.</p>	<table border="1"> <tr> <td data-bbox="807 165 911 244">  EN 1335 A </td> <td data-bbox="911 165 1015 244">  </td> <td data-bbox="1015 165 1118 244">  </td> <td colspan="3" data-bbox="1118 165 1217 244"></td> </tr> <tr> <td data-bbox="807 244 911 304">EN 1335 A</td> <td data-bbox="911 244 1015 304">CAM</td> <td data-bbox="1015 244 1118 304">1 M</td> <td colspan="3" data-bbox="1118 244 1217 304"></td> </tr> </table>					 EN 1335 A						EN 1335 A	CAM	1 M																						
 EN 1335 A																																					
EN 1335 A	CAM	1 M																																			
BRACCIOLI INCLUSI		<table border="1"> <tr> <td colspan="7" data-bbox="807 304 1217 483">  </td> </tr> <tr> <td data-bbox="807 483 863 555">A1</td> <td data-bbox="863 483 911 555">B</td> <td data-bbox="911 483 959 555">C</td> <td data-bbox="959 483 1007 555">D</td> <td data-bbox="1007 483 1054 555">E</td> <td data-bbox="1054 483 1102 555">F</td> <td data-bbox="1102 483 1150 555">G</td> </tr> <tr> <td data-bbox="807 555 863 584">102/120</td> <td data-bbox="863 555 911 584">58</td> <td data-bbox="911 555 959 584">45</td> <td data-bbox="959 555 1007 584">48</td> <td data-bbox="1007 555 1054 584">48</td> <td data-bbox="1054 555 1102 584">46/59</td> <td data-bbox="1102 555 1150 584">68</td> </tr> </table> <table border="1"> <tr> <td data-bbox="807 584 887 663">  </td> <td data-bbox="887 584 967 663">  </td> <td data-bbox="967 584 1046 663">  </td> <td data-bbox="1046 584 1126 663">  </td> <td data-bbox="1126 584 1217 663">GARANZIA</td> </tr> <tr> <td data-bbox="807 663 887 701">x 1</td> <td data-bbox="887 663 967 701">0,18</td> <td data-bbox="967 663 1046 701">18</td> <td data-bbox="1046 663 1126 701">120</td> <td data-bbox="1126 663 1217 701">2</td> </tr> </table>												A1	B	C	D	E	F	G	102/120	58	45	48	48	46/59	68					GARANZIA	x 1	0,18	18	120	2
																																					
A1	B	C	D	E	F	G																															
102/120	58	45	48	48	46/59	68																															
				GARANZIA																																	
x 1	0,18	18	120	2																																	
		<p>Schienale in RETE ignifuga (NERA), sedile in tessuto ignifugo BERLIN (NERO) 61681139</p>																																			

FERRET



FERRET

FRT A SY4 ABA SP	DESCRIZIONE		RIVESTIMENTO																														
	<p>SEDIA DA UFFICIO DIREZIONALE - OPERATIVA, ERGONOMICA REGOLABILE CON SCHIENALE IN RETE E SEDILE IMBOTTITO</p> <p>Schienale: fisso con struttura portante in acciaio verniciato nero.</p> <p>Poggiareni: regolabile in altezza tramite pomolo.</p> <p>Sedile: esterno in polipropilene, interno in multistrato di faggio 12mm rivestito in resina espansa ad alta densità (40 kg/m³), spessore 55mm.</p> <p>Braccioli: regolabili in altezza, in materiale plastico caricato, pad in materiale plastico.</p> <p>Meccanismo: sincro 4 blocchi con regolazione in base al peso dell'utilizzatore e dispositivo anti ritorno.</p> <p>Elevazione seduta: gaslift classe 4.</p> <p>Base: in nylon rinforzato + anello in acciaio di sicurezza separato da interporre tra gaslift e base per il sempre più richiesto facile riciclo dei singoli materiali.</p> <p>Ruote: autofrenanti di tipo W per tutti i pavimenti.</p>	 <table border="1" data-bbox="815 483 1206 555"> <thead> <tr> <th>A1</th> <th>B</th> <th>C</th> <th>D</th> <th>E</th> <th>F</th> <th>G</th> </tr> </thead> <tbody> <tr> <td>104/116</td> <td>65</td> <td>48</td> <td>44</td> <td>50</td> <td>42/54</td> <td>64</td> </tr> </tbody> </table> <table border="1" data-bbox="815 577 1206 696"> <thead> <tr> <th>Icona</th> <th>m³</th> <th>kg</th> <th>Garanzia</th> </tr> </thead> <tbody> <tr> <td></td> <td>x 1</td> <td>0,21</td> <td>16,5</td> </tr> <tr> <td></td> <td></td> <td></td> <td>110</td> </tr> <tr> <td></td> <td></td> <td></td> <td>3</td> </tr> </tbody> </table>	A1	B	C	D	E	F	G	104/116	65	48	44	50	42/54	64	Icona	m ³	kg	Garanzia		x 1	0,21	16,5				110				3	<p>Schienale in RETE (NERA) Sedile in TESSUTO ignifugo (GRIGIO) 93659371</p> <hr/> <p>Schienale in RETE (NERA) Sedile in TESSUTO ignifugo (NERO) 89046947</p>
A1	B	C	D	E	F	G																											
104/116	65	48	44	50	42/54	64																											
Icona	m ³	kg	Garanzia																														
	x 1	0,21	16,5																														
			110																														
			3																														
BRACCIOLI INCLUSI																																	

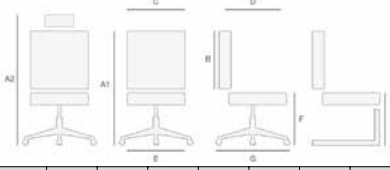
FRT B SY4 ABA SP	DESCRIZIONE		RIVESTIMENTO																														
	<p>SEDIA DA UFFICIO DIREZIONALE - OPERATIVA, ERGONOMICA REGOLABILE CON SCHIENALE IN RETE E SEDILE IMBOTTITO</p> <p>Schienale: fisso con struttura portante in acciaio verniciato nero.</p> <p>Poggiareni: regolabile in altezza tramite pomolo.</p> <p>Sedile: esterno in polipropilene, interno in multistrato di faggio 12mm rivestito in resina espansa ad alta densità (40 kg/m³), spessore 55mm.</p> <p>Braccioli: regolabili in altezza, in materiale plastico caricato, pad in materiale plastico.</p> <p>Meccanismo: sincro 4 blocchi con regolazione in base al peso dell'utilizzatore e dispositivo anti ritorno.</p> <p>Elevazione seduta: gaslift classe 4.</p> <p>Base: in nylon rinforzato + anello in acciaio di sicurezza separato da interporre tra gaslift e base per il sempre più richiesto facile riciclo dei singoli materiali.</p> <p>Ruote: autofrenanti di tipo W per tutti i pavimenti.</p>	 <table border="1" data-bbox="815 1131 1206 1202"> <thead> <tr> <th>A1</th> <th>B</th> <th>C</th> <th>D</th> <th>E</th> <th>F</th> <th>G</th> </tr> </thead> <tbody> <tr> <td>91/103</td> <td>54</td> <td>48</td> <td>44</td> <td>50</td> <td>42/54</td> <td>64</td> </tr> </tbody> </table> <table border="1" data-bbox="815 1225 1206 1344"> <thead> <tr> <th>Icona</th> <th>m³</th> <th>kg</th> <th>Garanzia</th> </tr> </thead> <tbody> <tr> <td></td> <td>x 1</td> <td>0,18</td> <td>15,5</td> </tr> <tr> <td></td> <td></td> <td></td> <td>110</td> </tr> <tr> <td></td> <td></td> <td></td> <td>3</td> </tr> </tbody> </table>	A1	B	C	D	E	F	G	91/103	54	48	44	50	42/54	64	Icona	m ³	kg	Garanzia		x 1	0,18	15,5				110				3	<p>Schienale in RETE (NERA) Sedile in TESSUTO ignifugo (GRIGIO) 48331706</p> <hr/> <p>Schienale in RETE (NERA) Sedile in TESSUTO ignifugo (NERO) 14806142</p>
A1	B	C	D	E	F	G																											
91/103	54	48	44	50	42/54	64																											
Icona	m ³	kg	Garanzia																														
	x 1	0,18	15,5																														
			110																														
			3																														
BRACCIOLI INCLUSI																																	

MODEL ONE



MODEL ONE

M ONE SY3 T ABA SP	DESCRIZIONE	RIVESTIMENTO																		
 <p>BRACCIOLI INCLUSI</p>	<p>SEDIA DA UFFICIO DIREZIONALE - OPERATIVA, ERGONOMICA REGOLABILE CON SCHIENALE IN RETE E SEDILE IMBOTTITO</p> <p>Schienale: fisso ed ergonomico. Poggiareni: regolabile in altezza. Sedile: esterno in polipropilene, interno in multistrato di faggio 12mm rivestito in resina espansa ad alta densità (40 kg/m³), spessore 55mm. Braccioli: regolabili in altezza, in materiale plastico caricato, pad in materiale plastico. Meccanismo: syncro 3 blocchi con regolazione in base al peso dell'utilizzatore e dispositivo anti ritorno. Traslatore per regolazione profondità della seduta. Elevazione seduta: gaslift classe 4. Base: in nylon rinforzato + anello in acciaio di sicurezza separato da interporre tra gaslift e base per il sempre più richiesto facile riciclo dei singoli materiali. Ruote: autofrenanti di tipo W per tutti i pavimenti.</p>	<p>CATAS </p> <p>EN 1335 B (in iter) CAM</p>																		
		<p>Schienale in RETE (NERA) Sedile in TESSUTO ignifugo (GRIGIO) 49325328</p>																		
<table border="1"> <thead> <tr> <th>A1</th> <th>B</th> <th>C</th> <th>D</th> <th>E</th> <th>F</th> <th>G</th> </tr> </thead> <tbody> <tr> <td>98/110</td> <td>59</td> <td>48</td> <td>45/50</td> <td>50</td> <td>42/54</td> <td>66</td> </tr> </tbody> </table>		A1	B	C	D	E	F	G	98/110	59	48	45/50	50	42/54	66	<p>Schienale in RETE (NERA) Sedile in TESSUTO ignifugo (NERO) 54179276</p>				
A1	B	C	D	E	F	G														
98/110	59	48	45/50	50	42/54	66														
<table border="1"> <thead> <tr> <th></th> <th></th> <th></th> <th></th> <th>GARANZIA</th> </tr> </thead> <tbody> <tr> <td>x 1</td> <td>0,18</td> <td>15,5</td> <td>110</td> <td>3</td> </tr> </tbody> </table>						GARANZIA	x 1	0,18	15,5	110	3									
				GARANZIA																
x 1	0,18	15,5	110	3																

OPTIONAL

APG M

<p>APPOGGIATESTA IN RETE</p> <p>96735823</p>

SIMPLEMESH



SIMPLEMESH

SM RT SY4 ABA1 SP	DESCRIZIONE	RIVESTIMENTO																																																																								
 <p>BRACCIOLI INCLUSI</p>	<p>SEDIA DA UFFICIO OPERATIVA CON SCHIENALE IN RETE E SEDILE IMBOTTITO</p> <p>Schienale: fisso ed ergonomico.</p> <p>Poggiareni: regolabile in altezza.</p> <p>Sedile: in polipropilene caricato ricoperto in resina espansa ad alta densità (40 kg/m³), spessore 40mm. Imbottitura estraibile per facile sostituzione.</p> <p>Braccioli: regolabili in altezza, in materiale plastico caricato, pad in materiale plastico.</p> <p>Meccanismo: syncro 4 blocchi con regolazione in base al peso dell'utilizzatore e dispositivo anti ritorno.</p> <p>Elevazione seduta: gaslift classe 4.</p> <p>Base: in nylon rinforzato + anello in acciaio di sicurezza separato da interporre tra gaslift e base per il sempre più richiesto facile riciclo dei singoli materiali.</p> <p>Ruote: autofrenanti di tipo W per tutti i pavimenti.</p>	<table border="1"> <tr> <td colspan="2" data-bbox="804 165 911 244">   </td> <td colspan="3" data-bbox="911 244 1011 304"> EN 1335 B (su richiesta) </td> <td colspan="2" data-bbox="1011 244 1112 304"> CAM </td> <td colspan="2" data-bbox="1112 244 1214 304"></td> </tr> <tr> <td colspan="9" data-bbox="804 304 1214 488">  </td> </tr> <tr> <td data-bbox="804 488 874 555"> A1 </td> <td data-bbox="874 488 911 555"> B </td> <td data-bbox="911 488 963 555"> C </td> <td data-bbox="963 488 1011 555"> D </td> <td data-bbox="1011 488 1059 555"> E </td> <td data-bbox="1059 488 1161 555"> F </td> <td data-bbox="1161 488 1214 555"> G </td> <td colspan="2" data-bbox="1214 488 1214 555"></td> </tr> <tr> <td data-bbox="804 555 874 584"> 97/109 </td> <td data-bbox="874 555 911 584"> 56 </td> <td data-bbox="911 555 963 584"> 49 </td> <td data-bbox="963 555 1011 584"> 44 </td> <td data-bbox="1011 555 1059 584"> 47 </td> <td data-bbox="1059 555 1161 584"> 42/54 </td> <td data-bbox="1161 555 1214 584"> 63 </td> <td colspan="2" data-bbox="1214 555 1214 584"></td> </tr> <tr> <td colspan="9" data-bbox="804 584 1214 667"> <table border="1"> <tr> <td data-bbox="804 584 884 667">  </td> <td data-bbox="884 584 963 667">  </td> <td data-bbox="963 584 1043 667">  </td> <td data-bbox="1043 584 1123 667">  </td> <td colspan="5" data-bbox="1123 584 1214 667"> GARANZIA </td> </tr> <tr> <td data-bbox="804 667 884 701"> x 1 </td> <td data-bbox="884 667 963 701"> 0,18 </td> <td data-bbox="963 667 1043 701"> 15 </td> <td data-bbox="1043 667 1123 701"> 110 </td> <td colspan="5" data-bbox="1123 667 1214 701"> 3 </td> </tr> </table> </td> </tr> </table>					 		EN 1335 B (su richiesta)			CAM													A1	B	C	D	E	F	G			97/109	56	49	44	47	42/54	63			<table border="1"> <tr> <td data-bbox="804 584 884 667">  </td> <td data-bbox="884 584 963 667">  </td> <td data-bbox="963 584 1043 667">  </td> <td data-bbox="1043 584 1123 667">  </td> <td colspan="5" data-bbox="1123 584 1214 667"> GARANZIA </td> </tr> <tr> <td data-bbox="804 667 884 701"> x 1 </td> <td data-bbox="884 667 963 701"> 0,18 </td> <td data-bbox="963 667 1043 701"> 15 </td> <td data-bbox="1043 667 1123 701"> 110 </td> <td colspan="5" data-bbox="1123 667 1214 701"> 3 </td> </tr> </table>													GARANZIA					x 1	0,18	15	110	3					<p>Schienale in RETE (NERA) Sedile in TESSUTO ignifugo (NERO) 67858153</p>				
 		EN 1335 B (su richiesta)			CAM																																																																					
																																																																										
A1	B	C	D	E	F	G																																																																				
97/109	56	49	44	47	42/54	63																																																																				
<table border="1"> <tr> <td data-bbox="804 584 884 667">  </td> <td data-bbox="884 584 963 667">  </td> <td data-bbox="963 584 1043 667">  </td> <td data-bbox="1043 584 1123 667">  </td> <td colspan="5" data-bbox="1123 584 1214 667"> GARANZIA </td> </tr> <tr> <td data-bbox="804 667 884 701"> x 1 </td> <td data-bbox="884 667 963 701"> 0,18 </td> <td data-bbox="963 667 1043 701"> 15 </td> <td data-bbox="1043 667 1123 701"> 110 </td> <td colspan="5" data-bbox="1123 667 1214 701"> 3 </td> </tr> </table>													GARANZIA					x 1	0,18	15	110	3																																																				
				GARANZIA																																																																						
x 1	0,18	15	110	3																																																																						

OVI









OVI

OVI RT SY4 ABA1 SP	DESCRIZIONE	RIVESTIMENTO																												
	<p>SEDIA DA UFFICIO OPERATIVA CON SCHIENALE IN RETE E SEDILE IMBOTTITO</p> <p>Schienale: fisso ed ergonomico.</p> <p>Poggiareni: regolabile in altezza.</p> <p>Sedile: in polipropilene caricato ricoperto in resina espansa ad alta densità (40 kg/m³) e resilienza, spessore 40mm. Imbottitura estraibile per facile sostituzione.</p> <p>Braccioli: regolabili in altezza, in materiale plastico caricato, pad in materiale plastico.</p> <p>Meccanismo: syncro 4 blocchi con regolazione in base al peso dell'utilizzatore e dispositivo anti ritorno.</p> <p>Elevazione seduta: gaslift classe 4.</p> <p>Base: in nylon rinforzato + anello in acciaio di sicurezza separato da interporre tra gaslift e base per il sempre più richiesto facile riciclo dei singoli materiali.</p> <p>Ruote: autofrenanti di tipo W per tutti i pavimenti.</p>	<p>CATAS </p> <p>EN 1335 B (su richiesta) CAM</p>																												
<p>BRACCIOLI INCLUSI</p>		 <table border="1" data-bbox="810 488 1214 555"> <thead> <tr> <th>A1</th> <th>B</th> <th>C</th> <th>D</th> <th>E</th> <th>F</th> <th>G</th> </tr> </thead> <tbody> <tr> <td>97/107</td> <td>54</td> <td>45</td> <td>43</td> <td>47</td> <td>42/54</td> <td>64</td> </tr> </tbody> </table> <table border="1" data-bbox="810 584 1214 698"> <thead> <tr> <th></th> <th></th> <th></th> <th></th> <th>GARANZIA</th> </tr> </thead> <tbody> <tr> <td>x 1</td> <td>0,18</td> <td>15</td> <td>110</td> <td>3</td> </tr> </tbody> </table> <p>Schienale in RETE (NERA) Sedile in TESSUTO ignifugo (NERO) 18847311</p>					A1	B	C	D	E	F	G	97/107	54	45	43	47	42/54	64					GARANZIA	x 1	0,18	15	110	3
A1	B	C	D	E	F	G																								
97/107	54	45	43	47	42/54	64																								
				GARANZIA																										
x 1	0,18	15	110	3																										

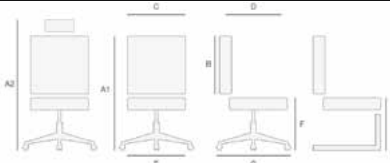
MODEL TWO



MODEL TWO

M TWO SY3 T ABA1 SP	DESCRIZIONE					RIVESTIMENTO																					
 <p data-bbox="150 676 338 698">BRACCIOLI INCLUSI</p>	<p data-bbox="399 219 790 253">SEDIA DA UFFICIO OPERATIVA CON SCHIENALE IN RETE E SEDILE IMBOTTITO</p> <p data-bbox="399 259 790 309">Schienale: ergonomico in nylon caricato fibra di vetro, fisso con appoggiareni regolabile in altezza.</p> <p data-bbox="399 315 790 383">Sedile: esterno ed interno in polipropilene rinforzato tramite tubolare in acciaio. Rivestito in resina espansa ad alta densità (30 kg/m³), spessore 50mm.</p> <p data-bbox="399 389 790 456">Meccanismo: syncro 3 blocchi con regolazione in base al peso dell'utilizzatore e dispositivo anti ritorno. Traslatore incluso per regolazione profondità della seduta.</p> <p data-bbox="399 463 790 486">Elevazione seduta: gaslift classe 4.</p> <p data-bbox="399 492 790 555">Base: in nylon rinforzato + anello in acciaio di sicurezza separato da interporre tra gaslift e base per il sempre più richiesto facile riciclo dei singoli materiali.</p> <p data-bbox="399 562 790 589">Ruote: autofrenanti di tipo W per tutti i pavimenti.</p>					<p data-bbox="1230 432 1489 499">Schienale in RETE (NERA) Sedile in TESSUTO ignifugo (NERO)</p> <p data-bbox="1315 499 1414 521">22111345</p>																					
<table border="1"> <thead> <tr> <th>A1</th> <th>B</th> <th>C</th> <th>D</th> <th>E</th> <th>F</th> <th>G</th> </tr> </thead> <tbody> <tr> <td>97/109</td> <td>54</td> <td>47</td> <td>45/50</td> <td>51</td> <td>42/54</td> <td>66</td> </tr> </tbody> </table>		A1	B	C	D		E	F	G	97/109	54	47	45/50	51	42/54	66	<table border="1"> <thead> <tr> <th></th> <th></th> <th></th> <th></th> <th>GARANZIA</th> </tr> </thead> <tbody> <tr> <td>x 1</td> <td>0,18</td> <td>15,5</td> <td>110</td> <td>3</td> </tr> </tbody> </table>						GARANZIA	x 1	0,18	15,5	110
A1	B	C	D	E	F	G																					
97/109	54	47	45/50	51	42/54	66																					
				GARANZIA																							
x 1	0,18	15,5	110	3																							

OPTIONAL

APG M

<p data-bbox="129 2056 359 2114">APPOGGIATESTA IN RETE</p>

96735823

GIUSTACCHINI
ARREDO

OP



OP

OP 450 CPT ABA1 SP	DESCRIZIONE	RIVESTIMENTO																																										
	<p>SEDIA DA UFFICIO OPERATIVA CON SCHIENALE IMBOTTITO</p> <p>Schienale: ergonomico in polipropilene rinforzato, regolabile in altezza con pomolo.</p> <p>Sedile: polipropilene caricato ricoperto in resina espansa ad alta densità (40 kg/m³) e resilienza, spessore 40mm. Imbottitura estraibile per facile sostituzione.</p> <p>Braccioli: regolabili in altezza, in materiale plastico caricato, pad in materiale plastico.</p> <p>Meccanismo: contattato permanente con pomolo laterale.</p> <p>Elevazione seduta: gaslift classe 4.</p> <p>Base: in nylon rinforzato + anello in acciaio di sicurezza separato da interporre tra gaslift e base per il sempre più richiesto facile riciclo dei singoli materiali.</p> <p>Ruote: autofrenanti di tipo W per tutti i pavimenti.</p>	<table border="1"> <tr> <td data-bbox="804 163 911 244">  EN 1335 B (su richiesta) </td> <td data-bbox="911 163 1011 244">  CAM </td> <td data-bbox="1011 163 1112 244"></td> <td data-bbox="1112 163 1212 244"></td> <td data-bbox="1212 163 1313 244"></td> <td data-bbox="1313 163 1414 244"></td> </tr> </table>					 EN 1335 B (su richiesta)	 CAM																																				
 EN 1335 B (su richiesta)	 CAM																																											
<p>BRACCIOLI INCLUSI</p>		<table border="1"> <tr> <td colspan="7" data-bbox="804 304 1212 481">  </td> </tr> <tr> <td data-bbox="804 481 863 555">A1</td> <td data-bbox="863 481 911 555">B</td> <td data-bbox="911 481 959 555">C</td> <td data-bbox="959 481 1007 555">D</td> <td data-bbox="1007 481 1054 555">E</td> <td data-bbox="1054 481 1102 555">F</td> <td data-bbox="1102 481 1150 555">G</td> </tr> <tr> <td data-bbox="804 555 863 584">97/110</td> <td data-bbox="863 555 911 584">52</td> <td data-bbox="911 555 959 584">46</td> <td data-bbox="959 555 1007 584">44</td> <td data-bbox="1007 555 1054 584">47</td> <td data-bbox="1054 555 1102 584">42/55</td> <td data-bbox="1102 555 1150 584">61</td> </tr> <tr> <td colspan="7" data-bbox="804 584 1212 672"> <table border="1"> <tr> <td data-bbox="804 584 884 667">  </td> <td data-bbox="884 584 963 667">  </td> <td data-bbox="963 584 1043 667">  </td> <td data-bbox="1043 584 1123 667">  </td> <td data-bbox="1123 584 1212 667"> GARANZIA </td> </tr> <tr> <td data-bbox="804 667 884 698">x 1</td> <td data-bbox="884 667 963 698">0,14</td> <td data-bbox="963 667 1043 698">14</td> <td data-bbox="1043 667 1123 698">110</td> <td data-bbox="1123 667 1212 698">5</td> </tr> </table> </td> </tr> </table>												A1	B	C	D	E	F	G	97/110	52	46	44	47	42/55	61	<table border="1"> <tr> <td data-bbox="804 584 884 667">  </td> <td data-bbox="884 584 963 667">  </td> <td data-bbox="963 584 1043 667">  </td> <td data-bbox="1043 584 1123 667">  </td> <td data-bbox="1123 584 1212 667"> GARANZIA </td> </tr> <tr> <td data-bbox="804 667 884 698">x 1</td> <td data-bbox="884 667 963 698">0,14</td> <td data-bbox="963 667 1043 698">14</td> <td data-bbox="1043 667 1123 698">110</td> <td data-bbox="1123 667 1212 698">5</td> </tr> </table>											GARANZIA	x 1	0,14	14	110	5
																																												
A1	B	C	D	E	F	G																																						
97/110	52	46	44	47	42/55	61																																						
<table border="1"> <tr> <td data-bbox="804 584 884 667">  </td> <td data-bbox="884 584 963 667">  </td> <td data-bbox="963 584 1043 667">  </td> <td data-bbox="1043 584 1123 667">  </td> <td data-bbox="1123 584 1212 667"> GARANZIA </td> </tr> <tr> <td data-bbox="804 667 884 698">x 1</td> <td data-bbox="884 667 963 698">0,14</td> <td data-bbox="963 667 1043 698">14</td> <td data-bbox="1043 667 1123 698">110</td> <td data-bbox="1123 667 1212 698">5</td> </tr> </table>											GARANZIA	x 1	0,14	14	110	5																												
				GARANZIA																																								
x 1	0,14	14	110	5																																								
		<p>Schienale in RETE (NERA) Sedile in TESSUTO ignifugo (NERO) 57389003</p>																																										

CHF

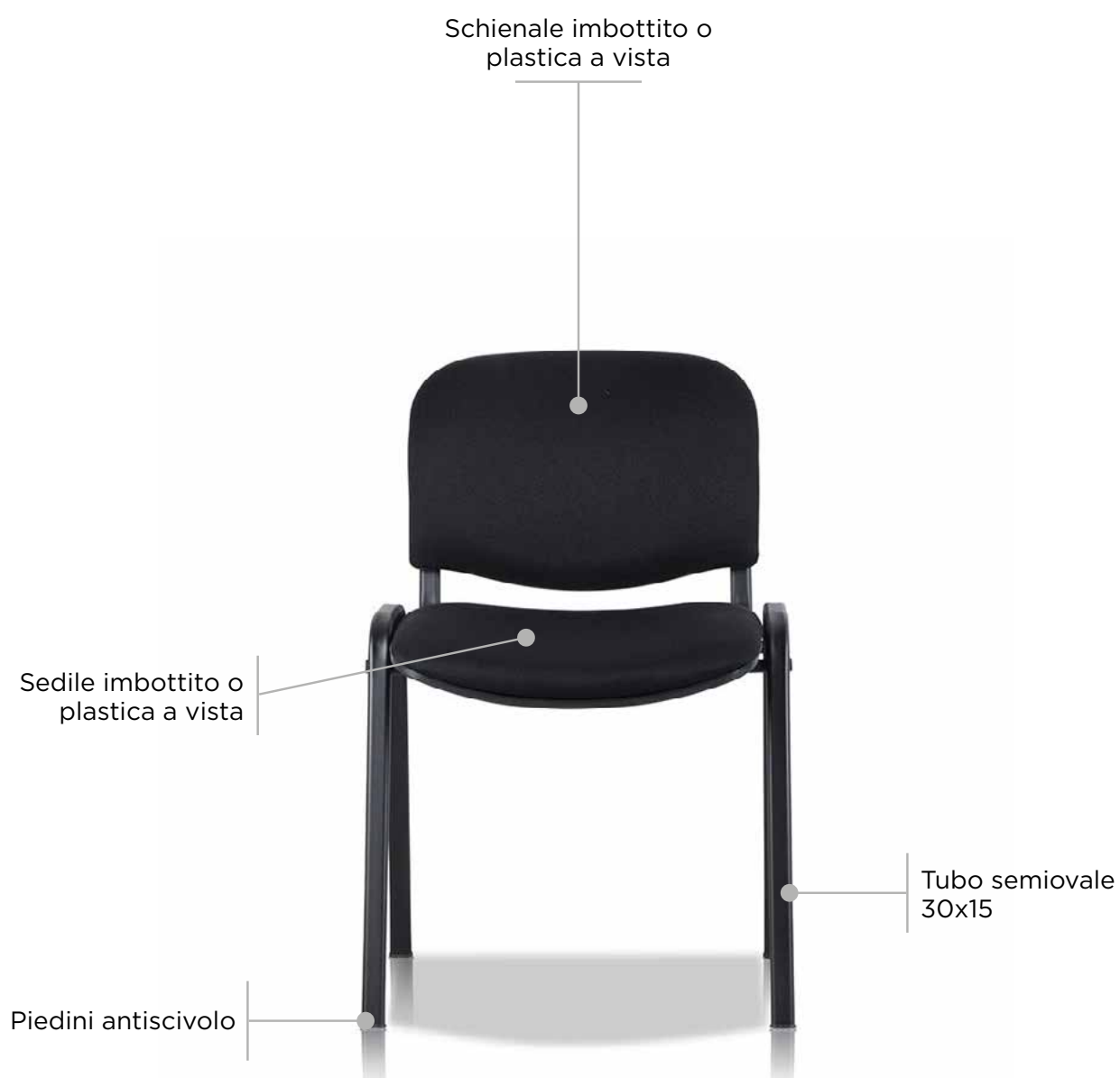

CHF TESSUTO

CHF TS ABA1 SP	DESCRIZIONE	 					RIVESTIMENTO
	<p>SEDUTA FISSA MULTIFUZIONE CON SCHIENALE E SEDILE IMBOTTITO E RIVESTITO</p> <p>Schienale: esterno ed interno in polipropilene, rivestito in resina espansa, spessore 30mm.</p> <p>Sedile: esterno ed interno in polipropilene, rivestito in resina espansa, spessore 30mm.</p> <p>Telaio: tubo semiovale 30x15 verniciato epossidico nero.</p> <p>Impilabile: fino a 10 pezzi con schienale montato.</p>	EN 16139	CAM				<p>Schienale in RETE (NERA) Sedile in TESSUTO ignifugo (NERO) 4x scatola (schienale smontato) 40699282</p>
							
		A1	B	C	D	E	
88	38	46	46	58	49	45	
							
x4	0,35	7x4	110	1			



CHF PLASTICA



CHF PP NR SP	DESCRIZIONE	 					RIVESTIMENTO
	<p>SEDUTA FISSA MULTIFUZIONE IN POLIPROPILENE A VISTA</p> <p>Schienale: plastica a vista colore nero.</p> <p>Sedile: plastica a vista colore nero.</p> <p>Telaio: tubo semiovale 30x15 verniciato epossidico nero.</p> <p>Impilabile: fino a 10 pezzi con schienale montato.</p>	EN 16139	CAM				<p>PLASTICA colore (NERO) 4X scatola (schienale smontato) 07274879</p>
							
		A1	B	C	D	E	
88	38	46	46	58	49	45	
							
x4	0,35	7x4	110	1			

SAP

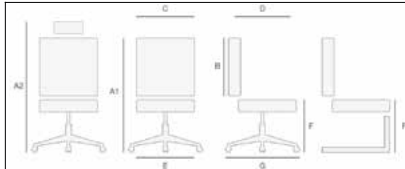

SAP

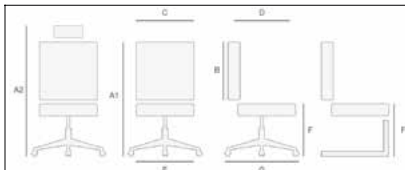
SAP SP	DESCRIZIONE					RIVESTIMENTO			
	<p>SEDIA TECNICA IN POLIURETANO MORBIDO A VISTA. Schienale: interno in plastica ricoperto di poliuretano, regolabile in altezza con pomolo. Sedile: interno in legno, ricoperto di poliuretano. Meccanismo: contatto permanente con pomolo laterale. Elevazione seduta: gaslift classe 4 + telescopico. Base: nylon caricato fibravetro. Ruote: nylon frenate siametro 50mm.</p>					<p>POLIURETANO (NERO) 68652290</p>			
									
		A1	B	C	D		E	F	G
		90	34	46	46		55	47	60
									
x1	0,08	14	110	5					

SAP SG SP	DESCRIZIONE					RIVESTIMENTO			
	<p>SEDIA TECNICA IN POLIURETANO MORBIDO A VISTA. Schienale: interno in plastica ricoperto di poliuretano, regolabile in altezza con pomolo. Sedile: interno in legno, ricoperto di poliuretano. Meccanismo: contatto permanente con pomolo laterale. Elevazione seduta: gaslift classe 4 + telescopico. Base: nylon caricato fibravetro. Piedini: nylon fissi.</p>					<p>POLIURETANO (NERO) 47963108</p>			
									
		A1	B	C	D		E	F	G
		100/126	31	42	44		48	64/90	63
									
x1	0,12	15	110	5					

■	WAVE	34-35
■	ALUMESH	36-37
■	BASIC	38-39
■	617	40-41
■	EMIRO	42-43
■	FICXRO	44-45
■	WH	
	FINTA PELLE	46-47
	RETE.....	48-49
■	VT NYLON	50-51
■	BRILLMESH	
	SCOCCA NERA.....	52-53
	SCOCCA BIANCA.....	54-55
■	KOS	56-57

IMPORT

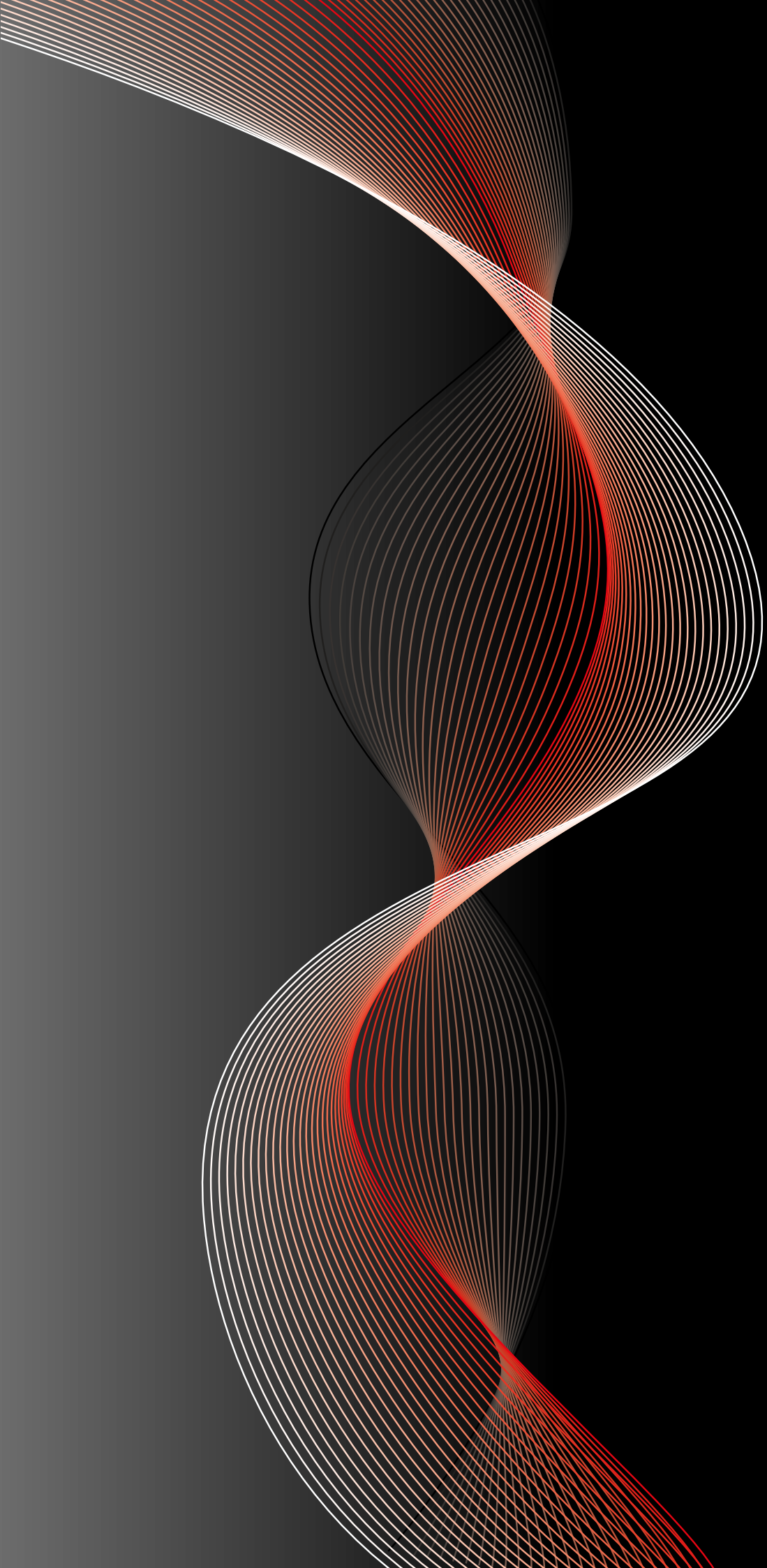

WAVE

Monoscocca rivestita con rete speciale e traspirante

Levetta in alluminio per regolazione altezza











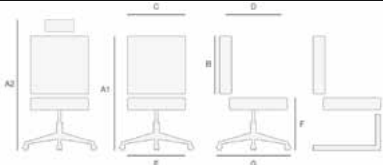

Levetta in alluminio per inclinazione schienale











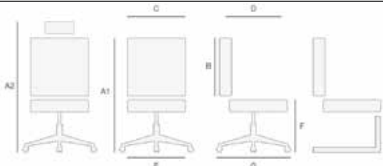

Base in alluminio

Ruote in nylon



WAVE







WAVE 110 IMP	DESCRIZIONE								RIVESTIMENTO																												
	<p>POLTRONA DIREZIONALE IN RETE SPECIALE Struttura: in nylon nero caricato di design ergonomico e moderno. Meccanismo: oscillante autoregolante in base al peso dell'utilizzatore. Elevazione seduta: gaslift. Base: in alluminio spazzolato diametro 68mm. Ruote: nylon libere.</p>	 <table border="1" data-bbox="810 488 1214 555"> <thead> <tr> <th>A1</th> <th>B</th> <th>C</th> <th>D</th> <th>E</th> <th>F</th> <th>G</th> <th></th> </tr> </thead> <tbody> <tr> <td>119/128</td> <td>76</td> <td>48</td> <td>46</td> <td>58</td> <td>46/55</td> <td>70</td> <td></td> </tr> </tbody> </table> <table border="1" data-bbox="810 577 1214 698"> <thead> <tr> <th></th> <th></th> <th></th> <th></th> <th colspan="2">GARANZIA</th> </tr> </thead> <tbody> <tr> <td>1</td> <td>0,27</td> <td>16</td> <td>110</td> <td>3</td> <td></td> </tr> </tbody> </table>							A1	B	C	D	E	F	G		119/128	76	48	46	58	46/55	70						GARANZIA		1	0,27	16	110	3		<p>Struttura in RETE (GRIGIA) 54867139</p>
A1	B	C	D	E	F	G																															
119/128	76	48	46	58	46/55	70																															
				GARANZIA																																	
1	0,27	16	110	3																																	
<p><i>BRACCIOLI INCLUSI</i></p>																																					

WAVE 80 IMP	DESCRIZIONE								RIVESTIMENTO																												
	<p>POLTRONCINA DIREZIONALE IN RETE SPECIALE Struttura: in nylon nero caricato di design ergonomico e moderno. Meccanismo: oscillante autoregolante in base al peso dell'utilizzatore. Elevazione seduta: gaslift. Base: in alluminio spazzolato diametro 68mm. Ruote: nylon libere.</p>	 <table border="1" data-bbox="810 1128 1214 1196"> <thead> <tr> <th>A1</th> <th>B</th> <th>C</th> <th>D</th> <th>E</th> <th>F</th> <th>G</th> <th></th> </tr> </thead> <tbody> <tr> <td>92-101</td> <td>50</td> <td>48</td> <td>46</td> <td>58</td> <td>45-54</td> <td>70</td> <td></td> </tr> </tbody> </table> <table border="1" data-bbox="810 1218 1214 1339"> <thead> <tr> <th></th> <th></th> <th></th> <th></th> <th colspan="2">GARANZIA</th> </tr> </thead> <tbody> <tr> <td>x1</td> <td>0,20</td> <td>15</td> <td>110</td> <td>3</td> <td></td> </tr> </tbody> </table>							A1	B	C	D	E	F	G		92-101	50	48	46	58	45-54	70						GARANZIA		x1	0,20	15	110	3		<p>Struttura in RETE (GRIGIA) 80769943</p>
A1	B	C	D	E	F	G																															
92-101	50	48	46	58	45-54	70																															
				GARANZIA																																	
x1	0,20	15	110	3																																	
<p><i>BRACCIOLI INCLUSI</i></p>																																					

ALUMESH

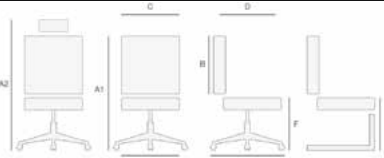

ALUMESH

AL 80 CHR IMP	DESCRIZIONE	 		RIVESTIMENTO			
	<p>POLTRONA DIREZIONALE ERGONOMICA REGOLABILE CON SCHIENALE IN RETE E SEDILE IMBOTTITO.</p> <p>Schienale: ergonomico rivestito in rete nera, esterno schienale in polipropilene rinforzato. Poggiatesta regolabile in altezza.</p> <p>Sedile: interno in polipropilene, imbottitura in schiumato rivestito con tessuto nero.</p> <p>Meccanismo: syncro in alluminio a 1 blocco con regolazione di tensione laterale.</p> <p>Braccioli: in alluminio e materiale plastico caricato, regolabili in altezza, profondità e rotazione.</p> <p>Elevazione seduta: gaslif.</p> <p>Base: in alluminio diametro 70mm.</p> <p>Ruote: nylon libere.</p>	ANSI-BIFMA X 5.1	UL 2818 - 2013		<p>Schienale in RETE (NERA) Sedile in TESSUTO ignifugo (GRIGIO) 57310966</p>		
<p>BRACCIOLI INCLUSI</p>							
	A1	B	C	D		E	F
	100/110	68	48	48	48	43/53	68
						GARANZIA	
		x 1	0,15	21	110	3	

OPTIONAL

APPOGGIATESTA

<p>APPOGGIATESTA IN TESSUTO COLORE NERO</p>

62270278

GIUSTACCHINI
ARREDO

BASIC

Rivestimento in finta pelle



Braccioli in
materiale plastico

Meccanismo oscillante

Base in nylon

Ruote autofrenanti
di tipo W per tutti i
pavimenti

BASIC

BASIC 10 IMP	DESCRIZIONE					RIVESTIMENTO														
	<p>POLTRONA DIREZIONALE</p> <p>Struttura: interno in multistrato ligneo ricoperto da resina espansa.</p> <p>Braccioli: fissi in polipropilene nero.</p> <p>Meccanismo: oscillante semplice regolazione in base al peso dell'utilizzatore.</p> <p>Elevazione seduta: gaslift.</p> <p>Base: in nylon rinforzato diametro 70mm.</p> <p>Ruote: nylon libere.</p>					<p>Finta PELLE (NERA) 90070740</p>														
<i>BRACCIOLI INCLUSI</i>		<table border="1"> <thead> <tr> <th>A1</th> <th>B</th> <th>C</th> <th>D</th> <th>E</th> <th>F</th> <th>G</th> </tr> </thead> <tbody> <tr> <td>117/125</td> <td>70</td> <td>49</td> <td>48</td> <td>62</td> <td>46/54</td> <td>68</td> </tr> </tbody> </table>	A1	B	C			D	E	F	G	117/125	70	49	48	62	46/54	68		
A1	B	C	D	E	F			G												
117/125	70	49	48	62	46/54	68														
		<table border="1"> <thead> <tr> <th></th> <th></th> <th></th> <th></th> <th>GARANZIA</th> </tr> </thead> <tbody> <tr> <td>x 1</td> <td>0,19</td> <td>16</td> <td>90</td> <td>1</td> </tr> </tbody> </table>								GARANZIA	x 1	0,19	16	90	1					
				GARANZIA																
x 1	0,19	16	90	1																

BASIC 5 IMP	DESCRIZIONE					RIVESTIMENTO														
	<p>POLTRONA VISITATORE E RIUNIONE</p> <p>Struttura: interno in multistrato ligneo ricoperto di resina espansa.</p> <p>Braccioli: fissi in polipropilene nero.</p> <p>Slitta: in tubo d'acciaio verniciato nero diametro 25mm.</p> <p>Piedini: nylon antiscivolo.</p>					<p>Finta PELLE (NERA) 51948996</p>														
<i>BRACCIOLI INCLUSI</i>		<table border="1"> <thead> <tr> <th>A1</th> <th>B</th> <th>C</th> <th>D</th> <th>E</th> <th>F</th> <th>G</th> </tr> </thead> <tbody> <tr> <td>98</td> <td>53</td> <td>49</td> <td>48</td> <td>62</td> <td>46</td> <td>52</td> </tr> </tbody> </table>	A1	B	C			D	E	F	G	98	53	49	48	62	46	52		
A1	B	C	D	E	F			G												
98	53	49	48	62	46	52														
		<table border="1"> <thead> <tr> <th></th> <th></th> <th></th> <th></th> <th>GARANZIA</th> </tr> </thead> <tbody> <tr> <td>x2</td> <td>0,24</td> <td>16</td> <td>90</td> <td>1</td> </tr> </tbody> </table>								GARANZIA	x2	0,24	16	90	1					
				GARANZIA																
x2	0,24	16	90	1																

617

Rivestimento in finta pelle













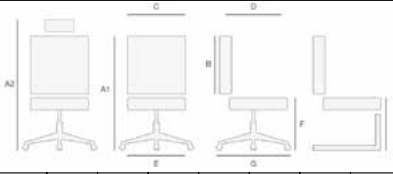

Braccioli in
materiale plastico

Meccanismo oscillante

Base in nylon

Ruote autofrenanti
di tipo W per tutti i
pavimenti

617

617 A IMP	DESCRIZIONE					RIVESTIMENTO																				
	<p>POLTRONA DIREZIONALE</p> <p>Struttura: interno in multistrato ligneo ricoperto da resina espansa.</p> <p>Braccioli: fissi in polipropilene.</p> <p>Meccanismo: oscillante semplice con regolazione in base al peso dell'utilizzatore.</p> <p>Elevazione seduta: gaslift.</p> <p>Base: in nylon rinforzato + anello in acciaio di sicurezza separato da interporre tra gaslift e base per il sempre più richiesto facile riciclo dei singoli materiali.</p> <p>Ruote: autofrenanti di tipo W per tutti i pavimenti.</p>					<p>Finta PELLE (NERA) 93258784</p>																				
<p><i>BRACCIOLI INCLUSI</i></p>		<table border="1"> <thead> <tr> <th>A1</th> <th>B</th> <th>C</th> <th>D</th> <th>E</th> <th>F</th> <th>G</th> <th></th> </tr> </thead> <tbody> <tr> <td>104/113</td> <td>65</td> <td>49</td> <td>47</td> <td>60</td> <td>42/51</td> <td>70</td> <td></td> </tr> </tbody> </table>							A1	B	C	D	E	F	G		104/113	65	49	47	60	42/51	70			
	A1	B	C	D	E			F	G																	
104/113	65	49	47	60	42/51	70																				
<table border="1"> <thead> <tr> <th></th> <th></th> <th></th> <th></th> <th>GARANZIA</th> </tr> </thead> <tbody> <tr> <td>x 1</td> <td>0,13</td> <td>16</td> <td>90</td> <td>1</td> </tr> </tbody> </table>					GARANZIA	x 1	0,13	16	90	1																
				GARANZIA																						
x 1	0,13	16	90	1																						

EMIRO

Rivestimento in finta pelle













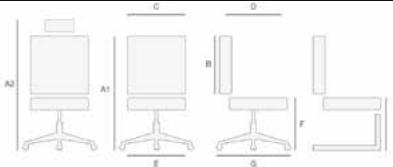

Braccioli in
materiale plastico

Meccanismo oscillante

Base in acciaio
cromato

Ruote autofrenanti
di tipo W per tutti i
pavimenti





EMIRO

EMIRO IMP	DESCRIZIONE					RIVESTIMENTO													
	<p>POLTRONA DIREZIONALE</p> <p>Struttura: interno in multistrato ligneo ricoperto da resina espansa.</p> <p>Braccioli: fissi in polipropilene.</p> <p>Meccanismo: oscillante semplice con regolazione in base al peso dell'utilizzatore.</p> <p>Elevazione seduta: gaslift.</p> <p>Base: in acciaio cromato diametro 70mm.</p> <p>Ruote: nylon libere.</p>					<p>Finta PELLE (NERA) 54274762</p>													
<p><i>BRACCIOLI INCLUSI</i></p>		<table border="1"> <thead> <tr> <th>A1</th> <th>B</th> <th>C</th> <th>D</th> <th>E</th> <th>F</th> <th>G</th> </tr> </thead> <tbody> <tr> <td>105/114</td> <td>67</td> <td>49</td> <td>45</td> <td>62</td> <td>43/53</td> <td>66</td> </tr> </tbody> </table>					A1	B	C	D	E	F	G	105/114	67	49	45	62	43/53
A1	B	C	D	E	F	G													
105/114	67	49	45	62	43/53	66													
		<table border="1"> <thead> <tr> <th></th> <th></th> <th></th> <th></th> <th>GARANZIA</th> </tr> </thead> <tbody> <tr> <td>x 1</td> <td>0,12</td> <td>18</td> <td>90</td> <td>1</td> </tr> </tbody> </table>								GARANZIA	x 1	0,12	18	90	1				
				GARANZIA															
x 1	0,12	18	90	1															



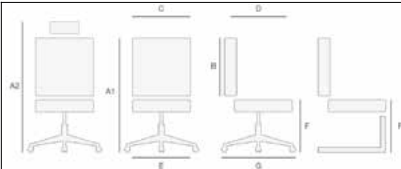
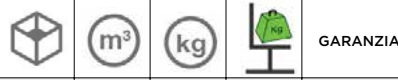

FIXCRO

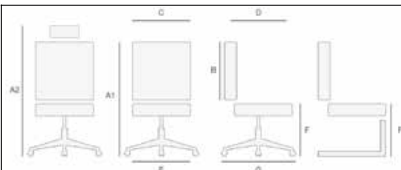

FIXCRO

FIXCRO NR IMP	DESCRIZIONE					RIVESTIMENTO			
	POLTRONA A SLITTA MULTI UTILIZZO , TELAIO CROMATO Monoscocca: struttura interna in mutistrato ligneo ricoperto di resina espansa. Slitta: in acciaio cromato diametro 22mm con braccioli incorporati e ricoperti. Piedini: nylon anti scivolo e anti ribaltamento.					PVC effetto cuoio (NERO) 99830727			
									
		A1	B	C	D		E	F	G
		98	52	50	47		56	46	60
								GARANZIA	
x 4		0,22		7x4		90		1	

BRACCIOLI INCLUSI NEL TELAIO

FIXCRO BN IMP	DESCRIZIONE					RIVESTIMENTO			
	POLTRONA A SLITTA MULTI UTILIZZO , TELAIO CROMATO Monoscocca: struttura interna in mutistrato ligneo ricoperto di resina espansa. Slitta: in acciaio cromato diametro 22mm con braccioli incorporati e ricoperti. Piedini: nylon anti scivolo e anti ribaltamento.					PVC effetto cuoio (BIANCO) 94899045			
									
		A1	B	C	D		E	F	G
		98	52	50	47		56	46	60
								GARANZIA	
x 4		0,22		7x4		90		1	

BRACCIOLI INCLUSI NEL TELAIO

WH FINTA PELLE

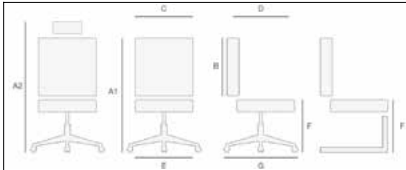

WH FINTA PELLE

WH A FP IMP	DESCRIZIONE	FINTA PELLE NERA / BIANCA		VARIANTI																															
 <p><i>BRACCIOLI INCLUSI</i></p>	<p>POLTRONA DIREZIONALE Monoscocca: struttura portante, tubo ovale 30x15 in acciaio cromato, imbottita e rivestita in finta pelle. Braccioli: fissi in acciaio cromato. Meccanismo: vedi colonna "VARIANTI". Elevazione seduta: gaslift classe 4. Base: girevole in acciaio cromato diametro 70mm. Ruote: Autofrenanti di tipo W tutti i pavimenti.</p>			<p>Oscillante semplice economico - (OSEC) 1 blocco 25134810</p>																															
		<table border="1"> <thead> <tr> <th>A1</th> <th>B</th> <th>C</th> <th>D</th> <th>E</th> <th>F</th> <th>G</th> </tr> </thead> <tbody> <tr> <td>108/120</td> <td>65</td> <td>44</td> <td>48</td> <td>48</td> <td>46/56</td> <td>70</td> </tr> </tbody> </table>	A1	B	C	D	E	F	G	108/120	65	44	48	48	46/56	70	<table border="1"> <thead> <tr> <th>Icona</th> <th>Valore</th> <th>Icona</th> <th>Valore</th> <th>Icona</th> <th>Valore</th> <th>Icona</th> <th>Valore</th> <th>GARANZIA</th> </tr> </thead> <tbody> <tr> <td></td> <td>x2</td> <td></td> <td>0,30</td> <td></td> <td>17</td> <td></td> <td>110</td> <td></td> <td>1</td> </tr> </tbody> </table>	Icona	Valore	Icona	Valore	Icona	Valore	Icona	Valore	GARANZIA		x2		0,30		17		110	
A1	B	C	D	E	F	G																													
108/120	65	44	48	48	46/56	70																													
Icona	Valore	Icona	Valore	Icona	Valore	Icona	Valore	GARANZIA																											
	x2		0,30		17		110		1																										

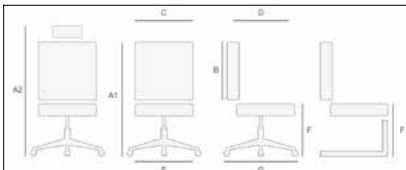
WH B FP IMP	DESCRIZIONE	FINTA PELLE NERA / BIANCA		VARIANTI																															
 <p><i>BRACCIOLI INCLUSI</i></p>	<p>POLTRONCINA VISITATORE Monoscocca: struttura portante, tubo ovale 30x15 in acciaio cromato, imbottita e rivestita in finta pelle. Braccioli: fissi in acciaio cromato. Meccanismo: vedi colonna "VARIANTI". Elevazione seduta: gaslift classe 4. Base: girevole in acciaio cromato diametro 70m. Ruote: Autofrenanti di tipo W tutti i pavimenti.</p>			<p>Piastra fissa - (PF) 50265642</p>																															
		<table border="1"> <thead> <tr> <th>A1</th> <th>B</th> <th>C</th> <th>D</th> <th>E</th> <th>F</th> <th>G</th> </tr> </thead> <tbody> <tr> <td>88/100</td> <td>46</td> <td>44</td> <td>48</td> <td>48</td> <td>44/56</td> <td>70</td> </tr> </tbody> </table>	A1	B	C	D	E	F	G	88/100	46	44	48	48	44/56	70	<table border="1"> <thead> <tr> <th>Icona</th> <th>Valore</th> <th>Icona</th> <th>Valore</th> <th>Icona</th> <th>Valore</th> <th>Icona</th> <th>Valore</th> <th>GARANZIA</th> </tr> </thead> <tbody> <tr> <td></td> <td>x2</td> <td></td> <td>0,30</td> <td></td> <td>16</td> <td></td> <td>110</td> <td></td> <td>1</td> </tr> </tbody> </table>	Icona	Valore	Icona	Valore	Icona	Valore	Icona	Valore	GARANZIA		x2		0,30		16		110	
A1	B	C	D	E	F	G																													
88/100	46	44	48	48	44/56	70																													
Icona	Valore	Icona	Valore	Icona	Valore	Icona	Valore	GARANZIA																											
	x2		0,30		16		110		1																										

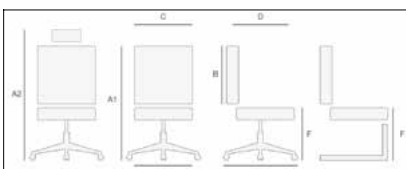
WH SL FP IMP	DESCRIZIONE	FINTA PELLE NERA / BIANCA		VARIANTI																															
 <p><i>BRACCIOLI INCLUSI</i></p>	<p>POLTRONA A SLITTA MULTI UTILIZZO Monoscocca: struttura portante, tubo ovale 30x15 in acciaio cromato, imbottita e rivestita in finta pelle. Slitta: tubo d'acciaio cromato diametro 30mm. Braccioli: fissi in acciaio cromato.</p>			<p>Slitta cromata 54429072</p>																															
		<table border="1"> <thead> <tr> <th>A1</th> <th>B</th> <th>C</th> <th>D</th> <th>E</th> <th>F</th> <th>G</th> </tr> </thead> <tbody> <tr> <td>91</td> <td>46</td> <td>44</td> <td>48</td> <td>48</td> <td>45</td> <td>58</td> </tr> </tbody> </table>	A1	B	C	D	E	F	G	91	46	44	48	48	45	58	<table border="1"> <thead> <tr> <th>Icona</th> <th>Valore</th> <th>Icona</th> <th>Valore</th> <th>Icona</th> <th>Valore</th> <th>Icona</th> <th>Valore</th> <th>GARANZIA</th> </tr> </thead> <tbody> <tr> <td></td> <td>x2</td> <td></td> <td>0,30</td> <td></td> <td>16</td> <td></td> <td>110</td> <td></td> <td>1</td> </tr> </tbody> </table>	Icona	Valore	Icona	Valore	Icona	Valore	Icona	Valore	GARANZIA		x2		0,30		16		110	
A1	B	C	D	E	F	G																													
91	46	44	48	48	45	58																													
Icona	Valore	Icona	Valore	Icona	Valore	Icona	Valore	GARANZIA																											
	x2		0,30		16		110		1																										

WH RETE

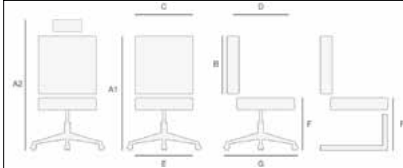
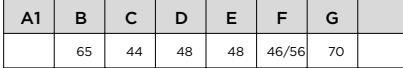

WH RETE

WH A RT IMP	DESCRIZIONE	RETE		VARIANTI																					
	POLTRONA DIREZIONALE Monoscocca: struttura portante, tubo ovale 30x15 in acciaio cromato, rivestita in rete portante. Braccioli: fissi in acciaio cromato. Meccanismo: vedi colonna "VARIANTI". Elevazione seduta: gaslift classe 4. Base: girevole in acciaio cromato diametro 70mm. Ruote: Autofrenanti di tipo W tutti i pavimenti.	RETE NERA	RETE BIANCA	Oscillante semplice economico - (OSEC) 1 blocco 45314734																					
				Oscillante semplice Italiano - (OSI) 1 blocco 72571209																					
BRACCIOLI INCLUSI				Oscillante avanzato - (OAC) 5 blocchi 18098999																					
		<table border="1"> <thead> <tr> <th>A1</th> <th>B</th> <th>C</th> <th>D</th> <th>E</th> <th>F</th> <th>G</th> </tr> </thead> <tbody> <tr> <td></td> <td>65</td> <td>44</td> <td>48</td> <td>48</td> <td>46/56</td> <td>70</td> </tr> </tbody> </table>		A1	B	C	D	E	F	G		65	44	48	48	46/56	70								
A1	B	C	D	E	F	G																			
	65	44	48	48	46/56	70																			
		<table border="1"> <thead> <tr> <th>Icona</th> <th>Valore</th> <th>Icona</th> <th>Valore</th> <th>Icona</th> <th>Valore</th> <th>Icona</th> <th>Valore</th> <th>Icona</th> <th>Valore</th> </tr> </thead> <tbody> <tr> <td></td> <td>2 x2lli</td> <td></td> <td>0,30</td> <td></td> <td>17</td> <td></td> <td>110</td> <td>GARANZIA</td> <td>1</td> </tr> </tbody> </table>		Icona	Valore	Icona	Valore	Icona	Valore	Icona	Valore	Icona	Valore		2 x2lli		0,30		17		110	GARANZIA	1		
Icona	Valore	Icona	Valore	Icona	Valore	Icona	Valore	Icona	Valore																
	2 x2lli		0,30		17		110	GARANZIA	1																

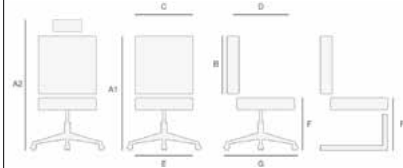
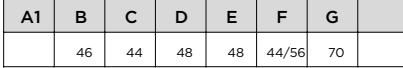

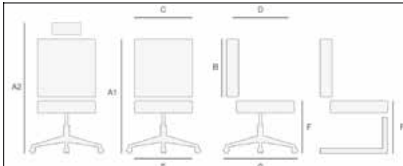
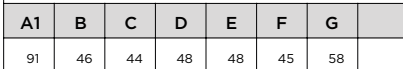
WH B FP IMP	DESCRIZIONE	RETE		VARIANTI																					
	POLTRONCINA VISITATORE Monoscocca: struttura portante, tubo ovale 30x15 in acciaio cromato, rivestita in rete portante. Braccioli: fissi in acciaio cromato. Meccanismo: vedi colonna "VARIANTI". Elevazione seduta: gaslift classe 4. Base: girevole in acciaio cromato diametro 70mm. Ruote: Autofrenanti di tipo W tutti i pavimenti.	RETE NERA	RETE BIANCA	Piastra fissa - (PF) 61811677																					
				Oscillante semplice economico - (OSEC) 1 blocco 61332508																					
BRACCIOLI INCLUSI				Oscillante semplice Italiano - (OSI) 1 blocco 52612071																					
		<table border="1"> <thead> <tr> <th>A1</th> <th>B</th> <th>C</th> <th>D</th> <th>E</th> <th>F</th> <th>G</th> </tr> </thead> <tbody> <tr> <td></td> <td>46</td> <td>44</td> <td>48</td> <td>48</td> <td>44/56</td> <td>70</td> </tr> </tbody> </table>		A1	B	C	D	E	F	G		46	44	48	48	44/56	70								
A1	B	C	D	E	F	G																			
	46	44	48	48	44/56	70																			
		<table border="1"> <thead> <tr> <th>Icona</th> <th>Valore</th> <th>Icona</th> <th>Valore</th> <th>Icona</th> <th>Valore</th> <th>Icona</th> <th>Valore</th> <th>Icona</th> <th>Valore</th> </tr> </thead> <tbody> <tr> <td></td> <td>2 x2lli</td> <td></td> <td>0,30</td> <td></td> <td>16</td> <td></td> <td>110</td> <td>GARANZIA</td> <td>1</td> </tr> </tbody> </table>		Icona	Valore	Icona	Valore	Icona	Valore	Icona	Valore	Icona	Valore		2 x2lli		0,30		16		110	GARANZIA	1		
Icona	Valore	Icona	Valore	Icona	Valore	Icona	Valore	Icona	Valore																
	2 x2lli		0,30		16		110	GARANZIA	1																



WH SL RT IMP	DESCRIZIONE	RETE		VARIANTI																					
	POLTRONA A SLITTA MULTI UTILIZZO. Monoscocca: struttura portante, tubo ovale 30x15 in acciaio cromato, rivestita in rete portante. Braccioli: fissi in acciaio cromato. Slitta: tubo d'acciaio cromato diametro 30mm.	RETE NERA	RETE BIANCA	Slitta cromata 81152636																					
																									
BRACCIOLI INCLUSI																									
		<table border="1"> <thead> <tr> <th>A1</th> <th>B</th> <th>C</th> <th>D</th> <th>E</th> <th>F</th> <th>G</th> </tr> </thead> <tbody> <tr> <td>91</td> <td>46</td> <td>44</td> <td>48</td> <td>48</td> <td>45</td> <td>58</td> </tr> </tbody> </table>		A1	B	C	D	E	F	G	91	46	44	48	48	45	58								
A1	B	C	D	E	F	G																			
91	46	44	48	48	45	58																			
		<table border="1"> <thead> <tr> <th>Icona</th> <th>Valore</th> <th>Icona</th> <th>Valore</th> <th>Icona</th> <th>Valore</th> <th>Icona</th> <th>Valore</th> <th>Icona</th> <th>Valore</th> </tr> </thead> <tbody> <tr> <td></td> <td>x2</td> <td></td> <td>0,30</td> <td></td> <td>16</td> <td></td> <td>110</td> <td>GARANZIA</td> <td>1</td> </tr> </tbody> </table>		Icona	Valore	Icona	Valore	Icona	Valore	Icona	Valore	Icona	Valore		x2		0,30		16		110	GARANZIA	1		
Icona	Valore	Icona	Valore	Icona	Valore	Icona	Valore	Icona	Valore																
	x2		0,30		16		110	GARANZIA	1																

VT NYLON

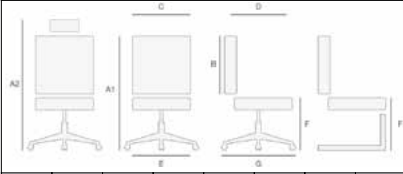

VT NYLON

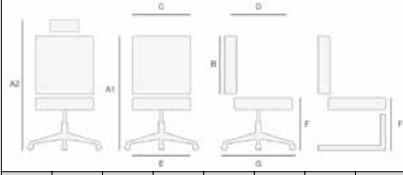



VT A PU	DESCRIZIONE							RIVESTIMENTO					
	<p>POLTRONA DIREZIONALE Monoscocca: struttura portante in nylon nero. Braccioli: fissi in nylon nero. Meccanismo: vedi colonna "VARIANTI". Elevazione seduta: gaslift classe 4. Base: in nylon rinforzato + anello in acciaio di sicurezza separato da interporre tra gaslift e base per il sempre più richiesto facile riciclo dei singoli materiali. Ruote: Autofrenanti di tipo W tutti i pavimenti.</p>							Oscillante semplice economico - (OSEC) 1 blocco 89003709					
									Oscillante semplice Italiano - (OSI) 1 blocco 51718978				
		A1	B	C	D	E	F	G					
115/126	72	51	48	56	43/54	67		Oscillante avanzato - (OAC) 5 blocchi 45676175					
<i>BRACCIOLI INCLUSI</i>				<table border="1"> <tr> <td>x2</td> <td>0,30</td> <td>17</td> <td>110</td> <td>1</td> </tr> </table>		x2	0,30	17	110	1	GARANZIA		
x2	0,30	17	110	1									





VT B PU	DESCRIZIONE							RIVESTIMENTO					
	<p>POLTRONCINA VISITATORE Monoscocca: struttura portante in nylon nero. Braccioli: fissi in nylon nero. Meccanismo: vedi colonna "VARIANTI". Elevazione seduta: gaslift classe 4. Base: in nylon rinforzato + anello in acciaio di sicurezza separato da interporre tra gaslift e base per il sempre più richiesto facile riciclo dei singoli materiali. Ruote: Autofrenanti di tipo W tutti i pavimenti.</p>							Oscillante semplice economico - (OSEC) 1 blocco 71118850					
									Oscillante semplice Italiano - (OSI) 1 blocco 00075865				
		A1	B	C	D	E	F	G					
97/108	54	51	48	56	43/54	67		Oscillante avanzato - (OAC) 5 blocchi 32472787					
<i>BRACCIOLI INCLUSI</i>				<table border="1"> <tr> <td>x2</td> <td>0,30</td> <td>16</td> <td>110</td> <td>1</td> </tr> </table>		x2	0,30	16	110	1	GARANZIA		
x2	0,30	16	110	1									

BRILLMESH



BRILLMESH (PLASTICA NERA)

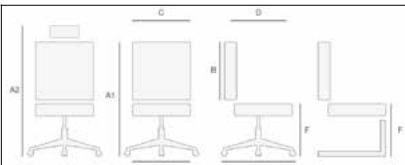











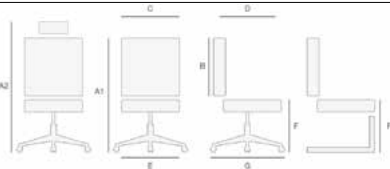

BRILL G IMP	DESCRIZIONE					RIVESTIMENTO														
	<p>SEDIA DA UFFICIO REGOLABILE IN ALTEZZA CON SCHIENALE IN RETE E SEDILE IMBOTTITO.</p> <p>Schienale: struttura portante in polipropilene nero, rivestito in rete.</p> <p>Sedile: interno in multistrato ligneo con imbottitura in resina e rivestimento in tessuto nero.</p> <p>Braccioli: fissi in polipropilene nero lucido.</p> <p>Meccanismo: oscillante semplice con regolazione di retenzione e blocco 1 posizione.</p> <p>Elevazione seduta: gaslift.</p> <p>Base: in acciaio cromato diametro 600mm.</p> <p>Ruote: libere in nylon gommate.</p>	 PLASTICA NERA				Schienale in RETE (GRIGIO) Sedile in TESSUTO ignifugo (NERO) 86475955														
							<table border="1"> <thead> <tr> <th>A1</th> <th>B</th> <th>C</th> <th>D</th> <th>E</th> <th>F</th> <th>G</th> </tr> </thead> <tbody> <tr> <td>93/106</td> <td>48</td> <td>41</td> <td>47</td> <td>47</td> <td>45/58</td> <td>63</td> </tr> </tbody> </table>	A1	B	C	D	E	F	G	93/106	48	41	47	47	45/58
		A1	B	C	D	E		F	G											
		93/106	48	41	47	47	45/58	63												
				<table border="1"> <tbody> <tr> <td>2 colli</td> <td>0,10</td> <td>11</td> <td>90</td> <td>1</td> </tr> </tbody> </table>		2 colli	0,10	11	90	1	Schienale in RETE (NERA) Sedile in TESSUTO ignifugo (NERO) 24578433									
2 colli	0,10	11	90	1																
BRACCIOLI INCLUSI																				













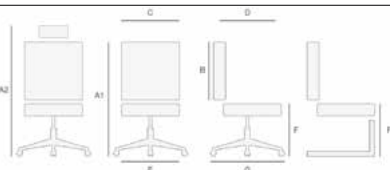

BRILL SL IMP	DESCRIZIONE					RIVESTIMENTO														
	<p>POLTRONCINA VISITATORE E RIUNIONE CON SCHIENALE IN RETE E SEDILE IMBOTTITO</p> <p>Schienale: struttura portante in polipropilene lucido nero, rivestito in rete.</p> <p>Sedile: interno in legno con imbottitura in resina e rivestimento in tessuto nero.</p> <p>Braccioli: fissi in polipropilene nero lucido.</p> <p>Slitta: in tubo d'acciaio cromato.</p>	 PLASTICA NERA				Schienale in RETE (GRIGIO) Sedile in TESSUTO ignifugo (NERO) 91091265														
							<table border="1"> <thead> <tr> <th>A1</th> <th>B</th> <th>C</th> <th>D</th> <th>E</th> <th>F</th> <th>G</th> </tr> </thead> <tbody> <tr> <td>93</td> <td>52</td> <td>49</td> <td>47</td> <td>48</td> <td>45</td> <td>62</td> </tr> </tbody> </table>	A1	B	C	D	E	F	G	93	52	49	47	48	45
		A1	B	C	D	E		F	G											
		93	52	49	47	48	45	62												
				<table border="1"> <tbody> <tr> <td>x2</td> <td>0,12</td> <td>10x2</td> <td>90</td> <td>1</td> </tr> </tbody> </table>		x2	0,12	10x2	90	1	Schienale in RETE (NERA) Sedile in TESSUTO ignifugo (NERO) 81915863									
x2	0,12	10x2	90	1																
BRACCIOLI INCLUSI																				

BRILLMESH



BRILLMESH (PLASTICA BIANCA)

BRILL G IMP	DESCRIZIONE							RIVESTIMENTO														
 <p><i>BRACCIOLI INCLUSI</i></p>	<p>SEDIA DA UFFICIO REGOLABILE IN ALTEZZA CON SCHIENALE IN RETE E SEDILE IMBOTTITO</p> <p>Schienale: struttura portante in polipropilene bianco, rivestito in rete.</p> <p>Sedile: interno in multistrato ligneo con imbottitura in resina e rivestimento in tessuto nero.</p> <p>Braccioli: fissi in polipropilene bianco lucido.</p> <p>Meccanismo: oscillante semplice con regolazione di tensione e blocco 1 posizione.</p> <p>Elevazione seduta: gaslift.</p> <p>Base: in acciaio cromato diametro 600mm.</p> <p>Ruote: libere in nylon gommate.</p>	 PLASTICA BIANCA						Schienale in RETE (BIANCO) Sedile in TESSUTO ignifugo (NERO) 23329365														
									Schienale in RETE (GRIGIO) Sedile in TESSUTO ignifugo (NERO) 08200466													
		<table border="1"> <thead> <tr> <th>A1</th> <th>B</th> <th>C</th> <th>D</th> <th>E</th> <th>F</th> <th>G</th> </tr> </thead> <tbody> <tr> <td>93/106</td> <td>48</td> <td>41</td> <td>47</td> <td>47</td> <td>45/58</td> <td>63</td> </tr> </tbody> </table>	A1	B	C	D	E	F	G	93/106	48	41	47	47	45/58	63						Schienale in RETE (ARANCIO) Sedile in TESSUTO ignifugo (NERO) 35542017
		A1	B	C	D	E	F	G														
93/106	48	41	47	47	45/58	63																
<table border="1"> <thead> <tr> <th></th> <th></th> <th></th> <th></th> <th>GARANZIA</th> </tr> </thead> <tbody> <tr> <td></td> <td></td> <td></td> <td></td> <td></td> </tr> <tr> <td>x2</td> <td>0,10</td> <td>11</td> <td>90</td> <td>1</td> </tr> </tbody> </table>					GARANZIA						x2	0,10	11	90	1				Schienale in RETE (BLU) Sedile in TESSUTO ignifugo (NERO) 12439795			
				GARANZIA																		
																						
x2	0,10	11	90	1																		

BRILL SL IMP	DESCRIZIONE							RIVESTIMENTO														
 <p><i>BRACCIOLI INCLUSI</i></p>	<p>POLTRONCINA VISITATORE E RIUNIONE CON SCHIENALE IN RETE E SEDILE IMBOTTITO</p> <p>Schienale: struttura portante in polipropilene lucido bianco, rivestito in rete.</p> <p>Sedile: interno in legno con imbottitura in resina e rivestimento in tessuto nero.</p> <p>Braccioli: fissi in polipropilene bianco lucido.</p> <p>Slitta: in tubo d'acciaio cromato.</p>	 PLASTICA BIANCA						Schienale in RETE (BIANCO) Sedile in TESSUTO ignifugo (NERO) 50535895														
									Schienale in RETE (GRIGIO) Sedile in TESSUTO ignifugo (NERO) 98862720													
		<table border="1"> <thead> <tr> <th>A1</th> <th>B</th> <th>C</th> <th>D</th> <th>E</th> <th>F</th> <th>G</th> </tr> </thead> <tbody> <tr> <td>93</td> <td>52</td> <td>49</td> <td>47</td> <td>48</td> <td>45</td> <td>62</td> </tr> </tbody> </table>	A1	B	C	D	E	F	G	93	52	49	47	48	45	62						Schienale in RETE (ARANCIO) Sedile in TESSUTO ignifugo (NERO) 63197467
		A1	B	C	D	E	F	G														
93	52	49	47	48	45	62																
<table border="1"> <thead> <tr> <th></th> <th></th> <th></th> <th></th> <th>GARANZIA</th> </tr> </thead> <tbody> <tr> <td></td> <td></td> <td></td> <td></td> <td></td> </tr> <tr> <td>x2</td> <td>0,12</td> <td>10x2</td> <td>90</td> <td>1</td> </tr> </tbody> </table>					GARANZIA						x2	0,12	10x2	90	1				Schienale in RETE (BLU) Sedile in TESSUTO ignifugo (NERO) 83474400			
				GARANZIA																		
																						
x2	0,12	10x2	90	1																		

KOS











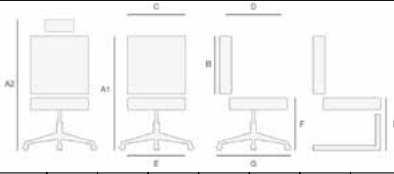

Scocca in plastica
a vista











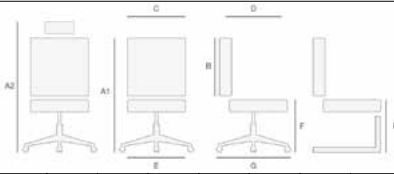



Gambe
in legno

Piedini antiscivolo

KOS

KOS NR IMP	DESCRIZIONE					RIVESTIMENTO																					
	<p>POLTRONA FISSA MULTIFUNZIONE CON POLIPROPILENE A VISTA Scocca: plastica a vista. Telaio: 4 piedi struttura in legno finitura faggio naturale. Piedini: nylon antiscivolo.</p>					<p>PLASTICA colore (NERO) 48045946</p>																					
<table border="1"> <thead> <tr> <th>A1</th> <th>B</th> <th>C</th> <th>D</th> <th>E</th> <th>F</th> <th>G</th> </tr> </thead> <tbody> <tr> <td>83</td> <td>42</td> <td>52</td> <td>42</td> <td>47</td> <td>45</td> <td>54</td> </tr> </tbody> </table>		A1	B	C	D		E	F	G	83	42	52	42	47	45	54	<table border="1"> <thead> <tr> <th></th> <th></th> <th></th> <th></th> <th>GARANZIA</th> </tr> </thead> <tbody> <tr> <td>x 4</td> <td>0,18</td> <td>5x4</td> <td>90</td> <td>1</td> </tr> </tbody> </table>						GARANZIA	x 4	0,18	5x4	90
A1	B	C	D	E	F	G																					
83	42	52	42	47	45	54																					
				GARANZIA																							
x 4	0,18	5x4	90	1																							

KOS BN IMP	DESCRIZIONE					RIVESTIMENTO																					
	<p>SEDUTA FISSA MULTIFUNZIONE IN POLIPROPILENE A VISTA Scocca: plastica a vista. Telaio: 4 piedi struttura in legno finitura faggio naturale. Piedini: nylon antiscivolo.</p>					<p>PLASTICA colore (BIANCO) 85722902</p>																					
<table border="1"> <thead> <tr> <th>A1</th> <th>B</th> <th>C</th> <th>D</th> <th>E</th> <th>F</th> <th>G</th> </tr> </thead> <tbody> <tr> <td>83</td> <td>42</td> <td>52</td> <td>42</td> <td>47</td> <td>45</td> <td>54</td> </tr> </tbody> </table>		A1	B	C	D		E	F	G	83	42	52	42	47	45	54	<table border="1"> <thead> <tr> <th></th> <th></th> <th></th> <th></th> <th>GARANZIA</th> </tr> </thead> <tbody> <tr> <td>x 4</td> <td>0,18</td> <td>5x4</td> <td>90</td> <td>1</td> </tr> </tbody> </table>						GARANZIA	x 4	0,18	5x4	90
A1	B	C	D	E	F	G																					
83	42	52	42	47	45	54																					
				GARANZIA																							
x 4	0,18	5x4	90	1																							

Sede Operativa

Viale Sant'Eufemia, 190
250135 - Brescia - IT

T. 0303690547

F. 0303690505

www.giustacchini.it

GIUSTACCHINI
ARREDO